

LED Full Color Controller

LED ovladač digitální DGSD FSD-1000D

přepínání mezi nastavením čipu/programu/a kontrastu C255-C000 zapnutí/vypnutí efektu



postupným mačkáním nastavení typu čipu, APAI počet čipů až 2048, /výběr efektu/rychlost/přidržením 3s přepnutí na DMX

tlačítko ubírání

tlačítko přidávání

● First, Overview:

- 1、 Inside the pattern 102, then control can be equipped with SD (<4G).
- 2、 Call internal pattern after the boot without SD, calling SD of animation effect after the boot with SD. FSD-1000D can send DMX512 & TTL signal.
- 3、 using standard DMX512 choose built-in patterns speed and R G B/RGBW.
- 4、 Can be more than one, the synchronization signal recommended no more than 50 meters, measured 100 meter.
- 5、 The maximum drive 2048 pixels. The maximum refresh rate of 30 frame rate (<512 pixels).
- 6、 The maximum distance between the controller and lighting TTL is <15m; 485 signal<30 meters, TTL simultaneously and then 10 or so pieces.

Power Supply	DC5-24V
Specifications	L122 *W 73* H25
Weight	0.2Kg
Power	3W

● Second, support IC:

Support IC	Specific models
TM	TM1803 TM1804 TM1913 TM1809 TM1812 TM1914, TM1829
UCS	UCS2903 UCS2909 UCS2912 UCS1903 UCS1909, UCS1912
WS	WS2801 WS2812 WS2811
INK1003	INK1003
LPD	LDP6803 LDP8806 LDP1109
D705	D705
SM	SM16716 SM16726 16703 DMX512
APA102	APA102
DMX512	DMX512
P9813 P9803	
SK6812	RGB/RGBW
Other models, please contact our advice.	

- **Three, automatic discriminant SD card or internal pattern**

Boot automatically when judging whether a card, a card call SD pattern, no card automatically calls the internal pattern.

- **pattern & speed.**

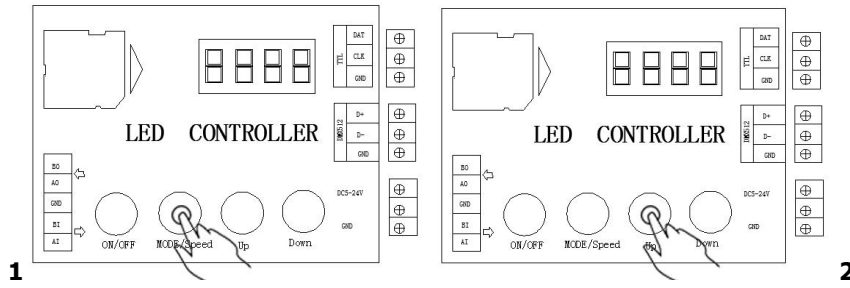

1、 under the SD card status ,you can select the pattern and speed through the key, where [on/off]key is invalid. No card and other operations, as detailed below.

2、 Press [mode/speed] Then second key to cycle through S001 and P001,S beginning representative rate, P beginning representative pattern (Figure 1),

this time through the [UP] and [DOWN] to increase or decrease.

3、 Press the second button [MODE/SPEED} to display A000,A representative DMX512 address, attention DMX address decode and use only standard DMX512 console

control only useful built-in patterns. Increases and decreases with the UP and DOWN keys.

- **Wiring**

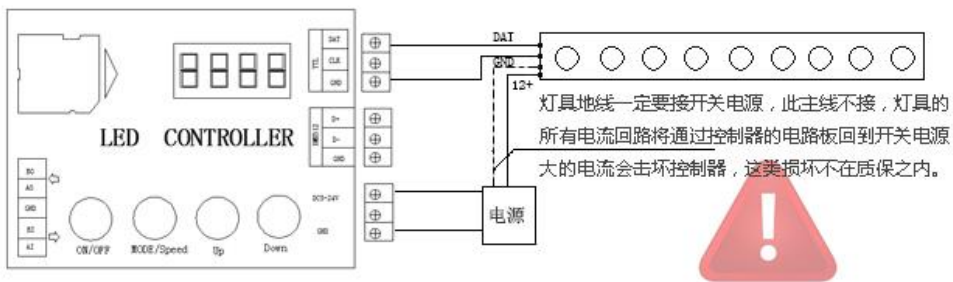
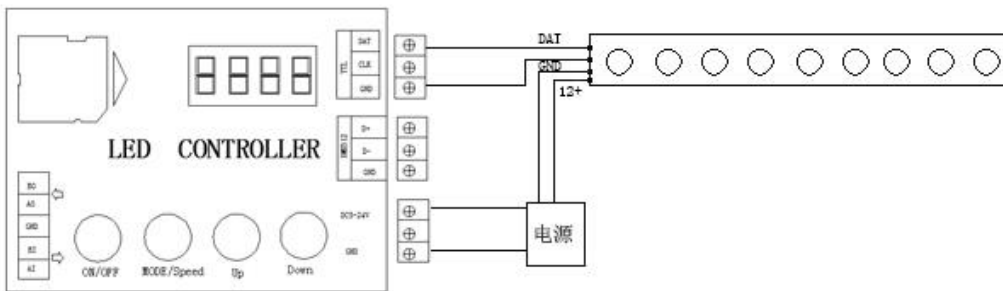

灯具地线一定要接开关电源，此主线不接，灯具的所有电流回路将通过控制器的电路板回到开关电源大的电流会击坏控制器，这类损坏不在质保之内。



[error]

- **Multiple controller for synchronous operation**

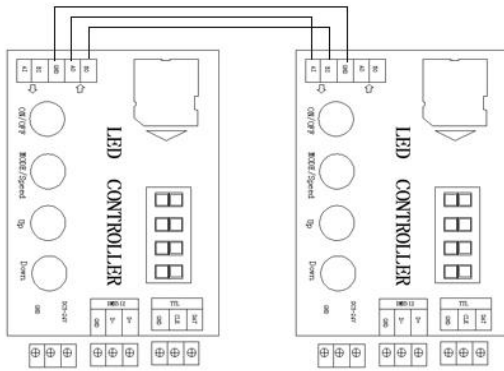

TTL: single-and two-wire signal interface.

DAT: Data

CLK: Clock

GND: Signal ground

DMX512: selected models DMX512 DMX 512 signal is sent, the differential signal is sent when the other models; board with 485 receiving the signal transmitted farther.

D+: DMX512 signal A

D-: DMX512 signal B,

GND: normal circumstances without wiring.

- Internal pattern instructions

- **Election IC Type:**

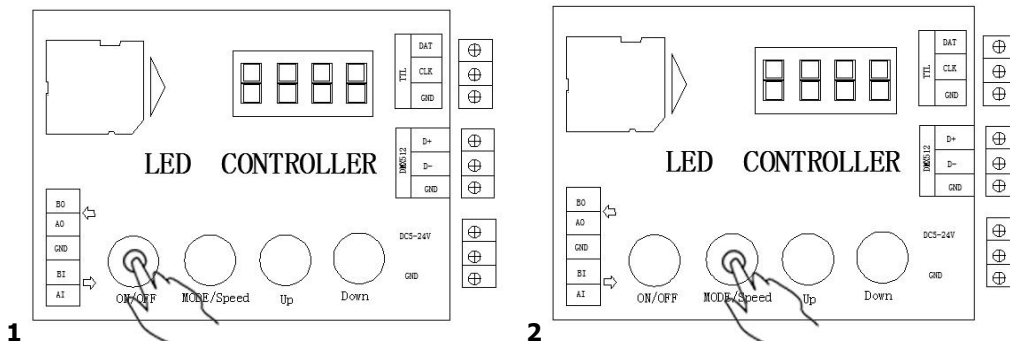

- First press the [ON/Off] key to display OFF enter programming mode (Figure 1)

- Then press the [Mode/Speed] Select (Figure 2), choose the right model and then take [On/Off] key to exit.

- **Control points set**

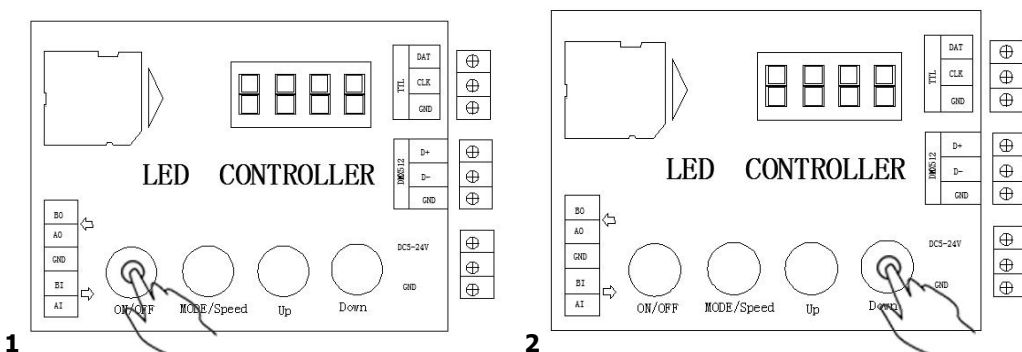

First press the [ON/OFF] key to enter the programming screen display OFF state.

[UP] and [DOWN] set points.

Then [On/Off] key to exit.

● DMX512

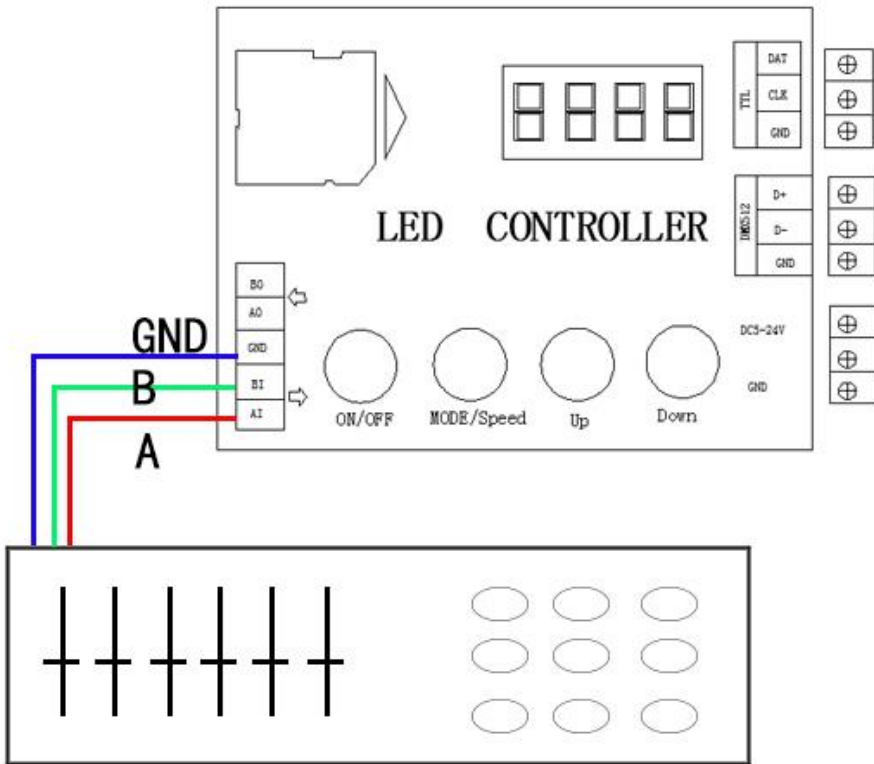

- 1、 using standard DMX512 choose built-in patterns speed and R G B/RGBW。
 - 2、 DMX512 5CH
1CH pattern
2CH speed
3CH-5CH: RGB brightness
 - 3、 pattern speed: $255/\text{pattern number}$ (for example: $255/(10\text{pattern}) = 25.5$, that means 0-25 is pattern 1, 26-52 is pattern 2)
 - 4、 DMX512 address is A000 , press Mode/Speed 2, then press UP Down to set the address, when change address, DMX512 change 5ch up/down。
- For example: A000 CH 1-5 A001 CH 6-10

Cautions

- 1、 This products Input voltage is DC5~24V, other input voltage are not allowed.
- 2、 Lead wire should be connected correctly, according to the wire color and the connecting diagram offers.
- 3、 Overload are prohibited.