

MyHOME

Smarter^{with} NETATMO

SXG/SXM/SXW8002 – XW/SXW8002W – XW/XM/XG8002

0 490 38 – 0 490 39 – 0 490 40

User and installation manual





Contents

Your Smarther, use it now!	5
Heat your home immediately (Boost)	5
Set the temperature	6
Installation	7
Flush-mounted installation (SXG8002 / SXM8002 / SXW8002)	7
With 503E boxes	7
With 500 boxes	8
With 502PB boxes	8
Wall-mounted installation SXW8002W	9
Front view	10
Symbols on the display	11
Rear view	12
SXG8002 / SXM8002 / SXW8002	12
<i>Wiring diagrams</i>	12
SXW8002W	13
<i>Wiring diagrams</i>	14
Technical data	15
Regulatory warnings	15
Operation	16
Basic functions	18
Boost functions	18
Set the temperature	20
Room humidity display	23
Control the Smarther with Home + Control app	24
Introduction	24
Download the Home + Control app	25
Account registration	26
Preliminary operations for the use of a smartphone with iOS operating system	27
Associate the Smarther	29
if you use a smartphone with Android operating system	30
If you use a smartphone with iOS operating system	34
Create a program using the guided procedure	40
Access your home through invitation	43
Forgotten password	44
Authentication	45
Home Page	46
Control a single device	48
<i>Set the temperature</i>	48
<i>Set the Boost function</i>	50
Control all the devices in the room	51
Control all the home devices	52
<i>Absent Function</i>	52
<i>Frost guard Function</i>	53
<i>Set a program for all the home devices</i>	54

Settings	55
Manage my home	55
Home parameters	55
Room settings	58
Smarther settings	60
Valve settings	69
Parameters	72
Schedules	73
Create a new program	73
Duplicate a program	74
Rename a program	75
Change a time interval	76
Activate a program	78
Delete a program	79
Copy-paste the days	80
Set point	81
Example of creation of a new program from an existing one	85
Thermal comfort	91
Chart	92
Manage my guests	93
Invite a user	94
Delete a user	94
Add a product to this home	95
Add valves to the Smarther thermostat	96
Install a new home	99
Quick selections	100
Help	101
My account	102
Tell us what you think!	108
Logout	108
Reset	109
Resetting the Wi-Fi configuration and the HOMEKIT settings	109
Reset to the factory settings	111
Manage your Smarther with third-party apps	114
Control your Smarther with HOMEKIT	115

Your Smarter, use it now!

Heat your home immediately (Boost)

You can switch your system on quickly with the BOOST function

ACTIVATION FROM DEVICE

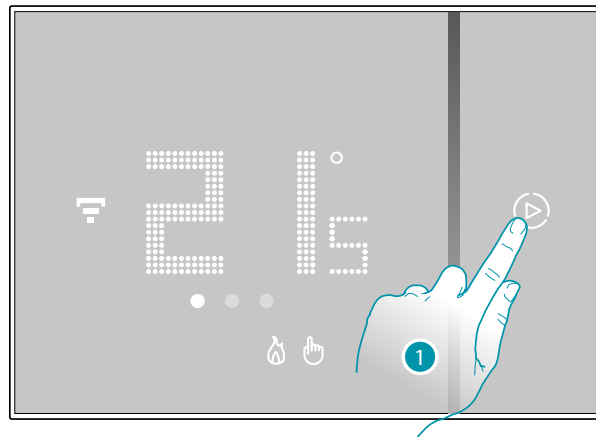

1. Touch to activate the function

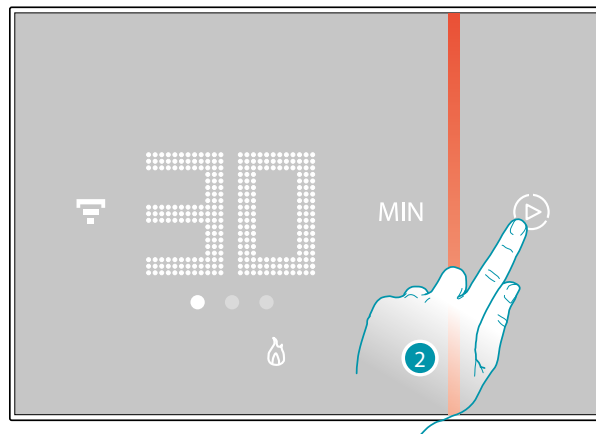

2. Select the switching-on period from 30/60/90 minutes

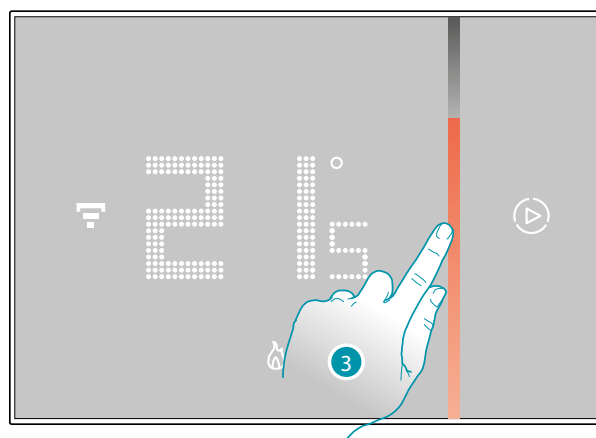

3. A visual indicator will show you the remaining time for which your system will remain on

or FROM APP

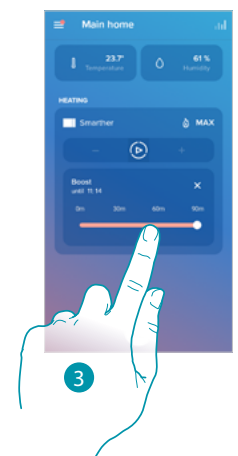
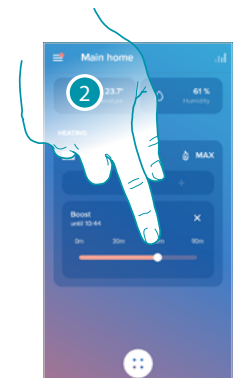
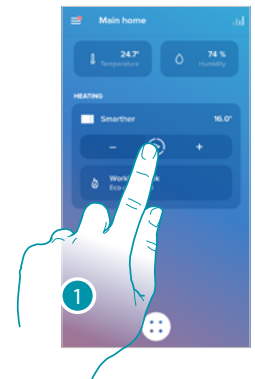

Set the temperature

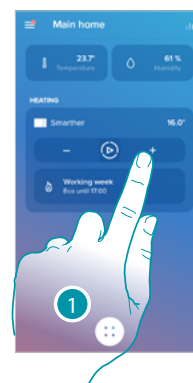
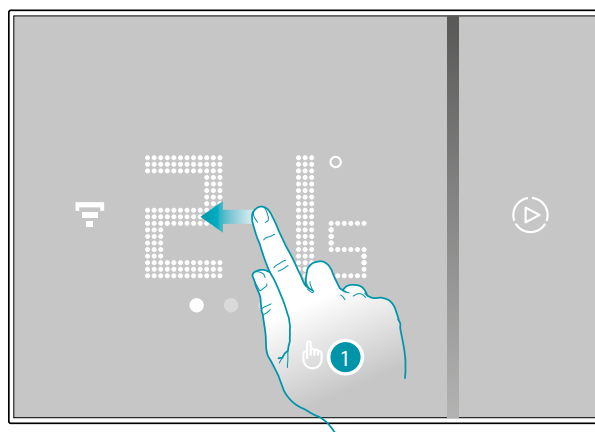

ACTIVATION FROM DEVICE

or FROM APP

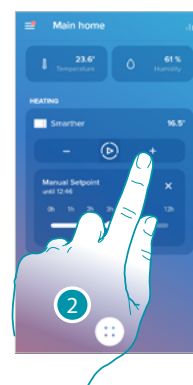
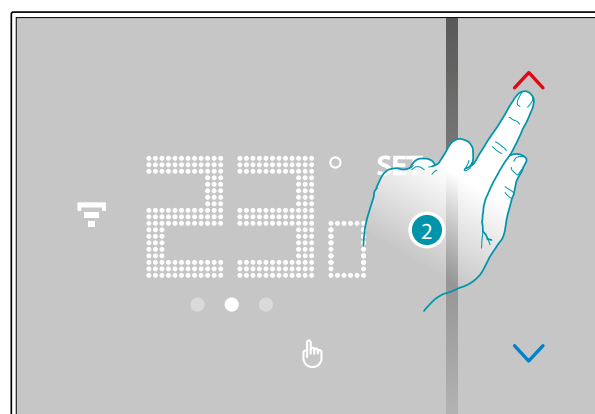

1. From the Smarter scroll to display the temperature setting page or, from the App, touch the icon



2. From the Smarter touch the  keys to increase or decrease the temperature, or from the App touch   to increase or decrease the temperature.

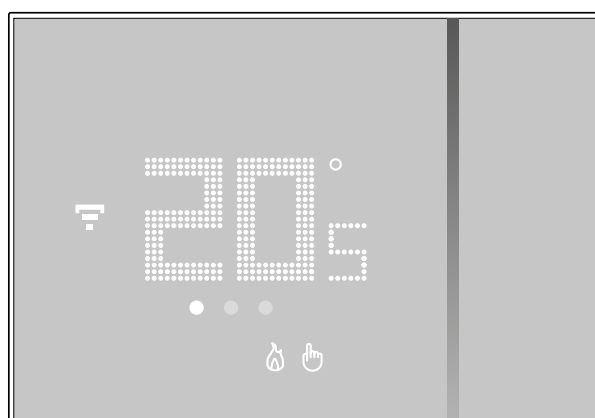

Note: when you want to set different temperatures depending on the time and day of the week, you need to create a special program (see [Schedules](#))

Installation

Flush-mounted installation (SXG8002 / SXM8002 / SXW8002)

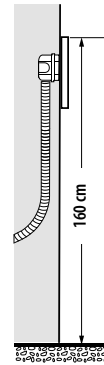
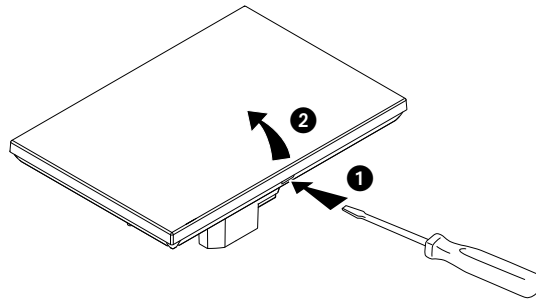

Recommended height,
unless different
regulations are specified

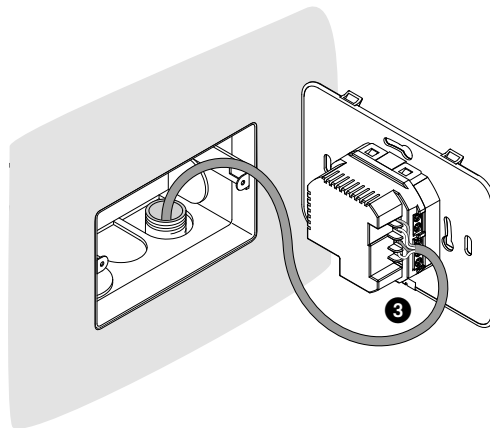

With 503E boxes

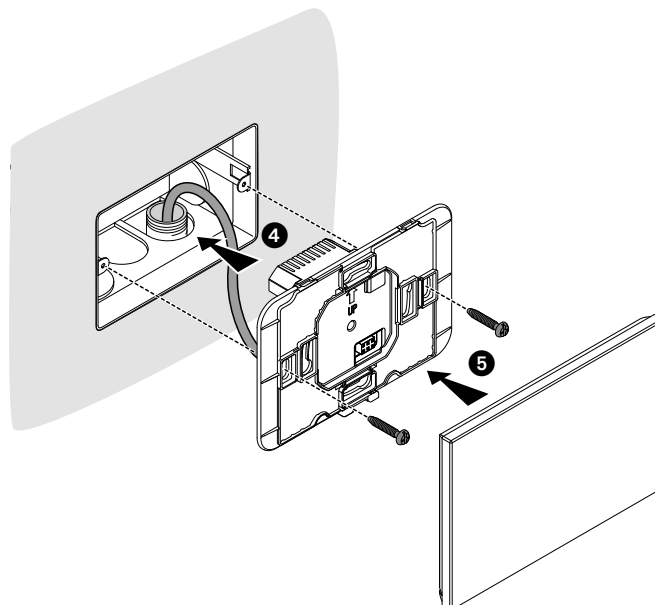

With 500 boxes

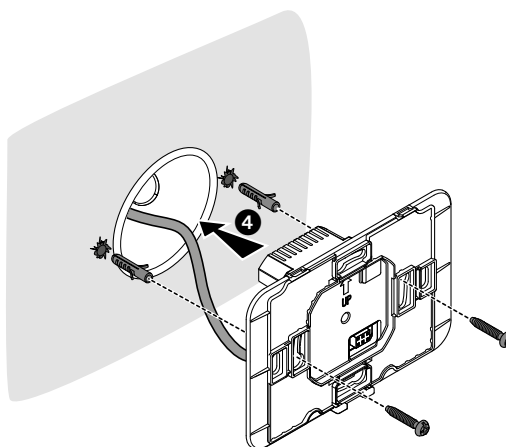

With 502PB boxes

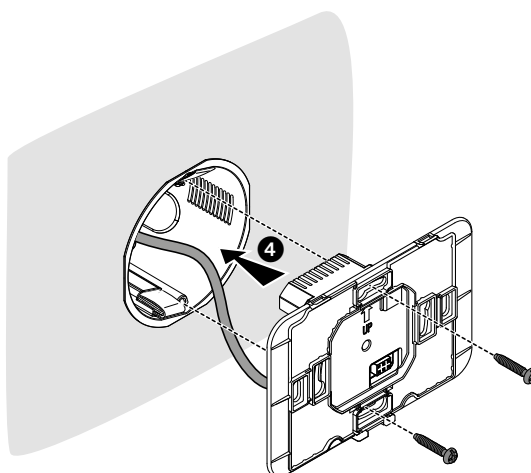

Caution: avoid tightening the screws too much, in order to prevent any base distortion that may compromise the correct installation of the device.
The front must be tightly fixed to the base and the fastening clip should lock into place.
Once the installation has been done, wait for 2 hours before checking the read temperature.

Wall-mounted installation SXW8002W

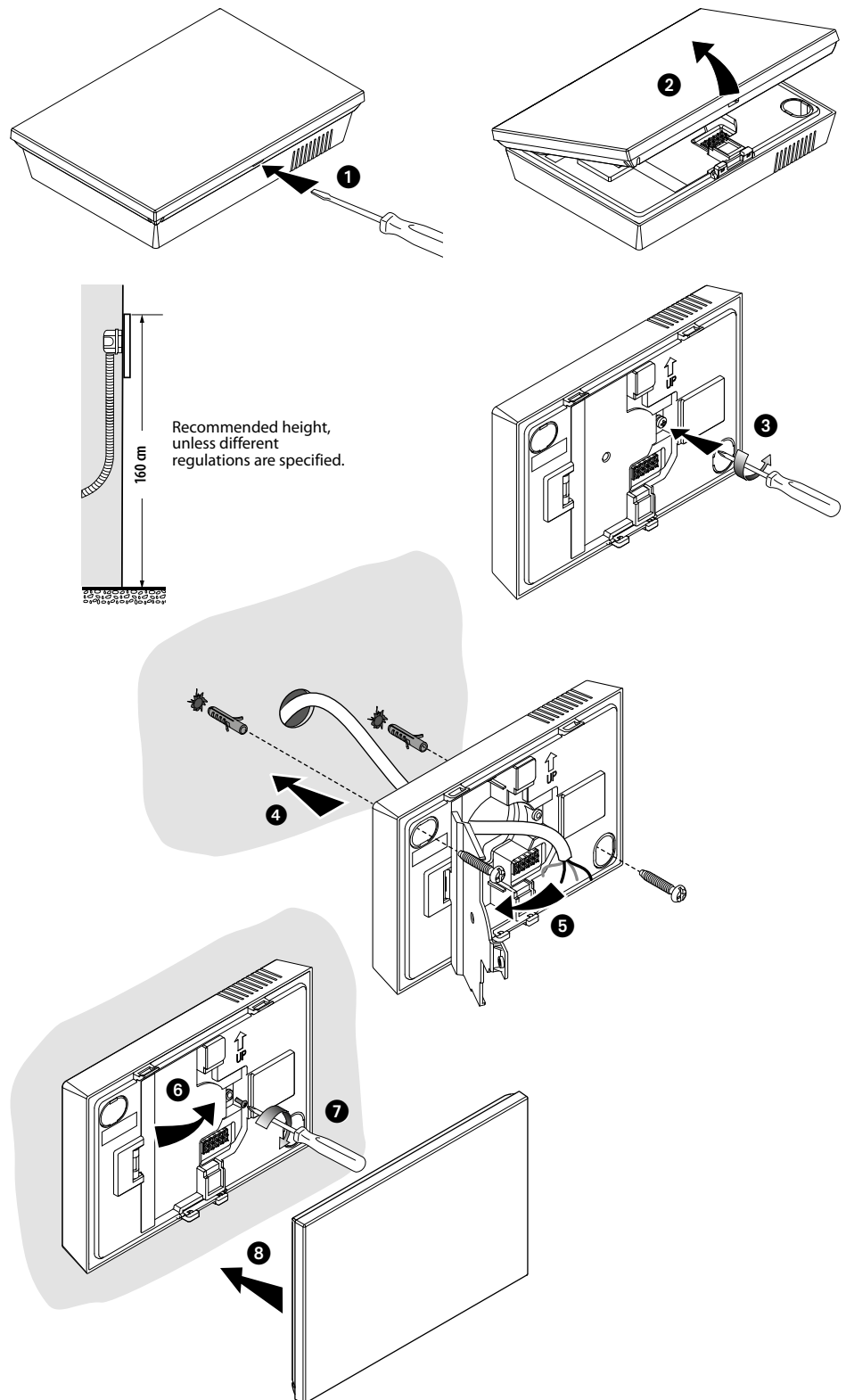

Caution: avoid fastening the base on irregular surfaces and excessive screw tightening, in order to prevent any base distortion that may compromise the correct installation of the device. The front must be tightly fixed to the base and the fastening clip should lock into place. Once the installation has been done, wait for 2 hours before checking the read temperature.



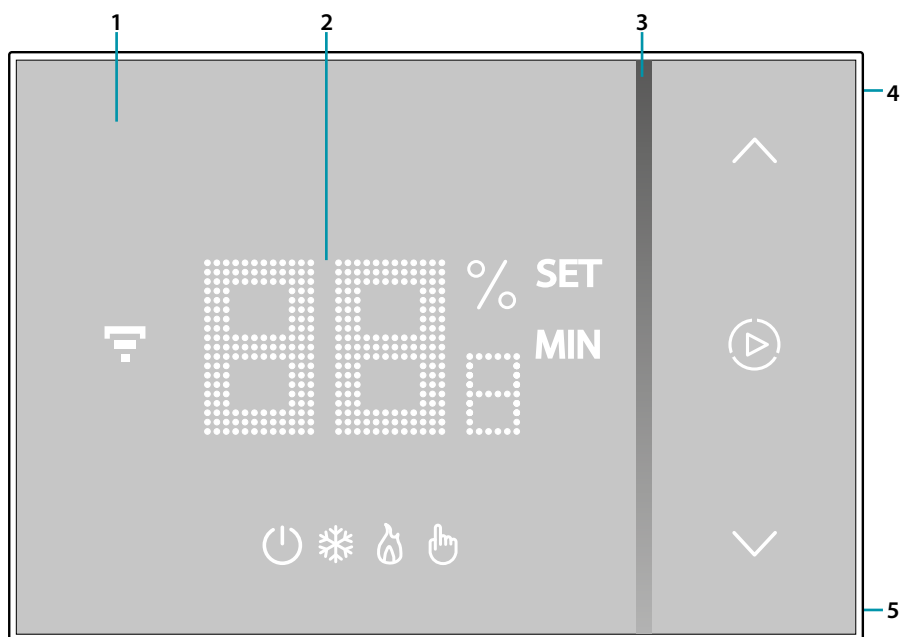



Front view



Note: the % ^{SET} _{MIN} ⏪, ⏩, 📶, icons are only on when the device is on. If the device is in stand by the icons will be off

1. Touch screen display
2. Temperature/humidity display
3. "Boost" mode indicator
4. Wi-Fi connection key
5. Reset Key

Symbols on the display

Icon	Meaning
 Smarther "OFF"	<p>SYSTEM IN HEATING MODE: The Smarther is set with a default temperature of 7 °C winter. You can set this condition from the App or manually, increasing or decreasing the temperature to the default values.</p> <p>SYSTEM IN COOLING MODE: The Smarther is OFF</p>
 Heating mode operation	The system is in heating mode and is ON.
 Cooling mode operation	The system is in cooling mode and is ON.
 Manual mode operation	The manual mode temporarily excludes the hour programs; using the Home + Control App you can also set the length of this mode. When this time has elapsed, operation will start again as in the program
 Boost mode activation	The Boost forces the switching on of the system for a limited time (30, 60 or 90 minutes) independent of the measured and programmed temperature
 Keys for temperature setting	The set value is only valid for the manual mode operation.
 Wi-Fi connection indicator	<p>ON = connected OFF = disconnected</p> <p>Blue flashing = it means that the device is ready for the association to the Home + Control app</p> <p>White flashing = it identifies the Smarther in some procedures, in case there is more than one in the system.</p>

Note: the images of this manual are only indicative, and therefore may not exactly represent the characteristics of the product.

Rear view

SXG8002 / SXM8002 / SXW8002

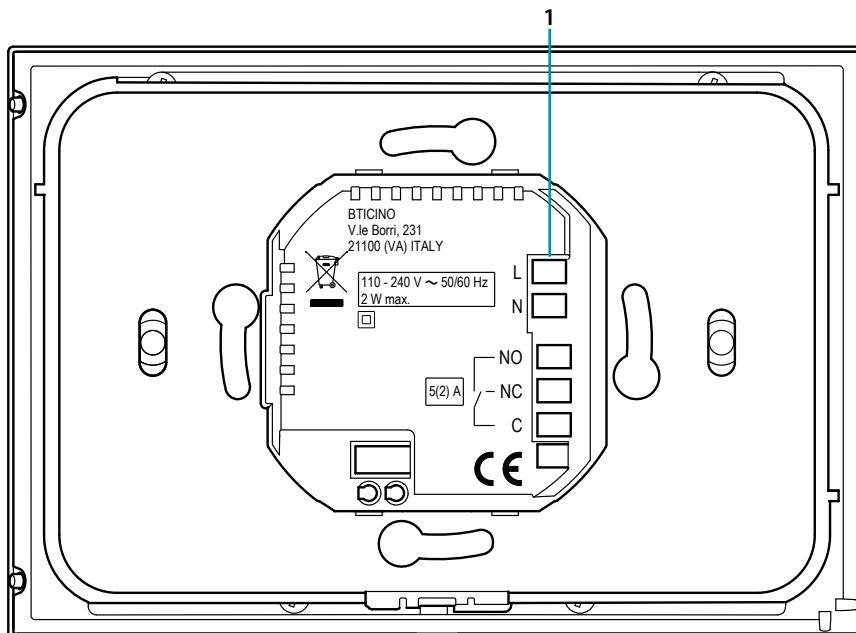

1. Connection clamps (see diagrams)

Wiring diagrams

System only for heating with clean contact (e.g. boiler activation)

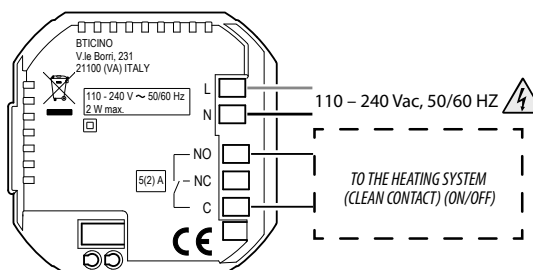

System only for heating with load to be controlled to the mains voltage (e.g. 230Vac solenoid valve or other loads, contact output 5(2) A)

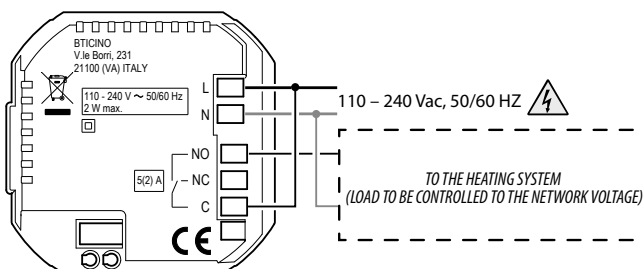

Heating and cooling with floor system

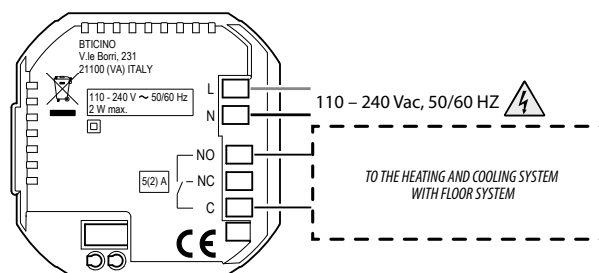

Heating and cooling with different systems

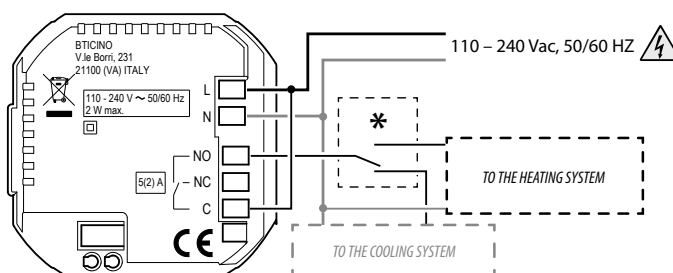

- * External changeover switch must be properly switched when system function is changed from heating to cooling and vice versa.

SXW8002W

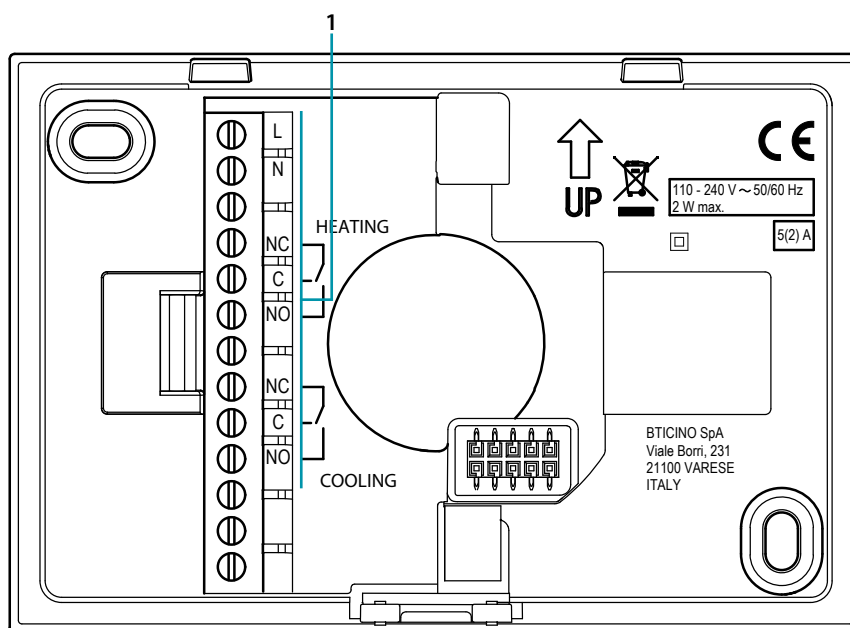

1. Connection clamps ([see diagrams](#))

Wiring diagrams

System only for heating with clean contact (e.g. boiler activation)

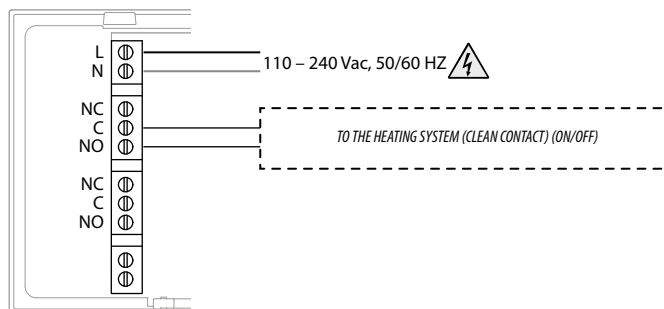

System only for heating with load to be controlled to the mains voltage (e.g. 230Vac solenoid valve or other loads, contact output 5(2) A)

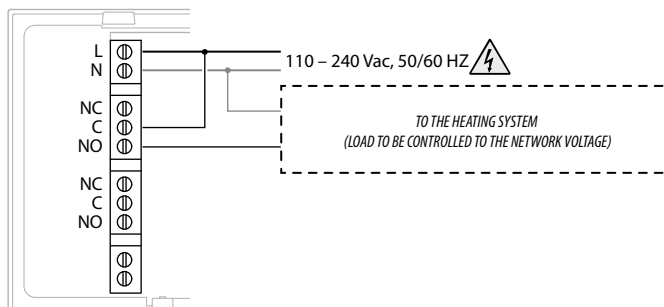

Heating and cooling with floor system

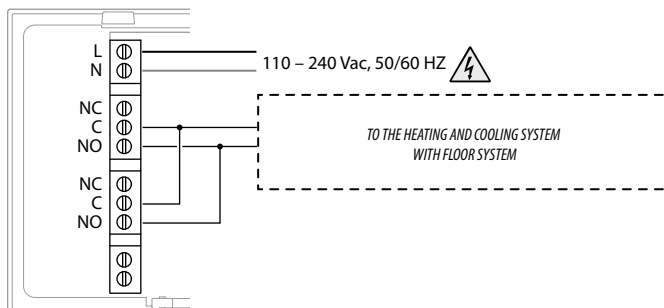

Heating and cooling with different systems

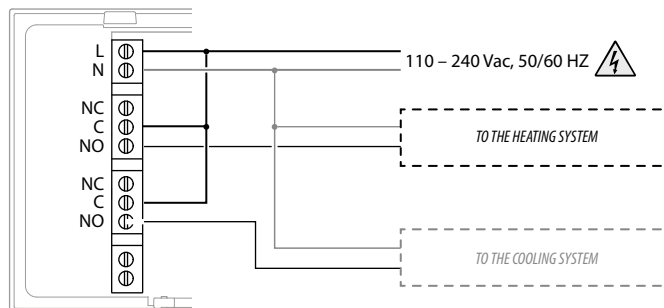



Technical data

Power supply	110 – 240 Vac , 50/60Hz
Absorption	2 W max
Maximum cable section	1 x 1,5mm ²
Contact output	5(2) A
Operating temperature	5 – 40 °C
Setpoint temperature	5 – 30 °C heating; increase of 0,5 °C
	5 – 40 °C cooling; increase of 0,5 °C
Type of operation	1BU
Pollution index	2
Rated pulse voltage	4 kV
Wireless device in compliance with 802.11b/g/n standard, frequency 2.4 – 2.4835 GHz, transmission power < 20 dBm. WEP/WPA/WPA2 safety protocol. IPv4 protocol.	
Radio connection: short range communication, 868MHz/915MHz frequency, transmission power < 25mW e.r.p.	

Regulatory warnings

- 

Read carefully before use and keep for future reference
- 

Touching the units with wet hands is forbidden
 Using liquid cleaners or aerosols is forbidden
 Blocking the ventilation openings is forbidden
 Modifying the devices is forbidden
 Removing protective parts from the devices is forbidden
 Installing the units near liquids and powders is forbidden
 Installing the units near heat sources is forbidden
 Installing the units near harmful gases, metal dusts or similar is forbidden
 Fastening the units on unsuitable surfaces is forbidden
- 

Danger of electrical shock
- 

Risk of devices falling because the surface on which they are installed collapses or inappropriate installation
 Switch the power supply OFF before any work on the system
- 

Caution: Installation, configuration, starting-up and maintenance must be performed exclusively by qualified personnel.
 Check that the wall installation has been carried out correctly
 Lay out the wires respecting the standards in force
 Connect the power supply wires as indicated
 Use only the items indicated in the technical specifications for any system expansions

Operation

In basic mode the Smarter allows you to adjust the temperature manually and switch the system on for a limited time (Boost mode). The advanced functions are available through the Home + Control App, which can be downloaded free from the Stores (for iOS devices from App Store, for Android devices from Play Store). In advanced mode you can plan the [schedules](#). The smartphone on which the Home + Control App is installed and the Smarter communicate via the device's Wi-Fi connection. You therefore do not need wire connections or a mains power supply and connections with the heating system.

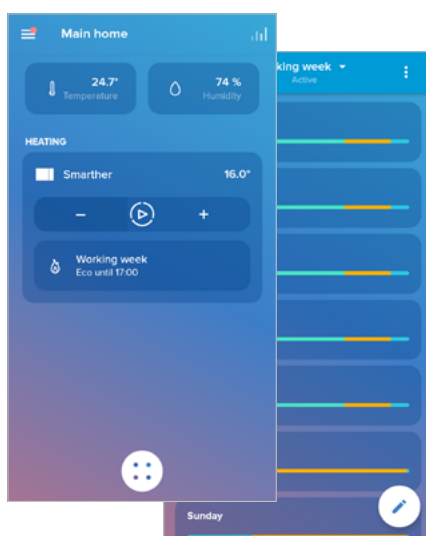

Functions	Functions available and differences between newly installed Smarter and Smarter connected with App		
	Smarter just installed (not connected)	Smarter connected with the App	
		By Smarter	By App
Boost 	<input checked="" type="checkbox"/>	<input checked="" type="checkbox"/>	<input checked="" type="checkbox"/>
At the end of the set period the Smarter returns to the mode which was active before the activation	At the end of the set period the Smarter returns to the program in progress.	At the end of the set period the Smarter returns to the program in progress.	At the end of the set period the Smarter returns to the program in progress.
Switching off 	<input checked="" type="checkbox"/>	<input checked="" type="checkbox"/>	<input checked="" type="checkbox"/>
The set mode is permanent	The set mode is permanent	The set mode is permanent	The set mode is permanent
I set the temperature 	<input checked="" type="checkbox"/>	<input checked="" type="checkbox"/>	<input checked="" type="checkbox"/>
The set temperature is permanent	The set temperature has a fixed time (default 3 hours) which can be modified from the App	The set temperature has a fixed time (default 3 hours) which can be modified	The set temperature has a fixed time (default 3 hours) which can be modified
Display the humidity 	<input checked="" type="checkbox"/>	<input checked="" type="checkbox"/>	<input checked="" type="checkbox"/>
Displayed in the third page	Displayed in the third page	Displayed in the Home Page	
Frost guard mode	<input checked="" type="checkbox"/>	<input checked="" type="checkbox"/>	<input checked="" type="checkbox"/>
Absent mode	<input checked="" type="checkbox"/>	<input checked="" type="checkbox"/>	<input checked="" type="checkbox"/>

Functions	Functions available and differences between newly installed Smarter and Smarter connected with App		
	Smarter just installed (not connected)	By Smarter	By App
Settings			
			<ul style="list-style-type: none"> – Heating/cooling switch (default: heating) – Enable touch interface (default: enabled) – Display brightness (*) (default: automatic without switching off) – Heating protection temperature (default: 7 °C) – Temperature calibration – Beep activation (default: disabled) – Vibration activation (default: enabled)
Program of a daily or weekly temperature profile			
Management of several Smarter and several houses			

(*) display brightness levels: **Off, Automatic without switching off, Automatic with switching off, Customised**

Note: a domestic Wi-Fi with internet access is needed for the connection between the Smarter and the smartphone. To use the service, the Customer must acquire the technical equipment which allows access to the Internet, on the basis of an agreement made by the Customer himself with an ISP (Internet Service Provider). BTicino plays no part in this.

Install the dedicated Home + Control application on your smartphone to program and use the Smarter. The services offered by means of the App require being able to interact with Smarter remotely and through the Internet. In these cases the integration and good working between Smarter and App may depend on:

- a) quality of the Wi-Fi signal;
- b) quality of the data signal;

We would like to inform you that the remote use via the App involves the use of data. The cost linked to data usage depends on the type of contract which the customer has with his ISP (Internet Service Provider) and is solely the customer's responsibility.

Basic functions

Boost functions

The Boost forces the switching on of the system for a limited time (30, 60 or 90 minutes) independent of the measured and programmed temperature.

Once the time set has elapsed, Smarter will resume operation according to the previous program.

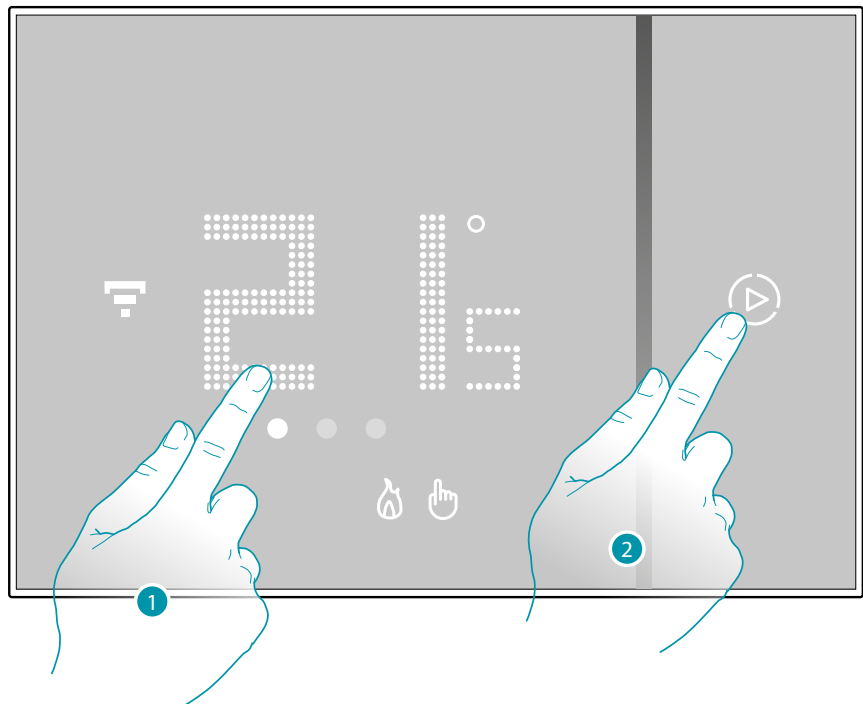

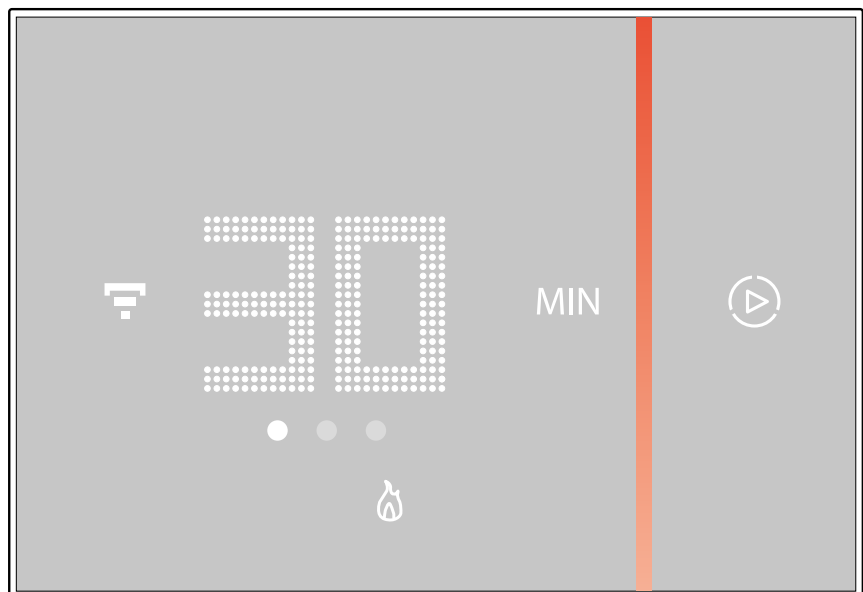

1. Touch the display, the symbol  comes on
2. Touch the symbol once or more to set the function duration; the display shows the set time, at the same time the LED lights up.

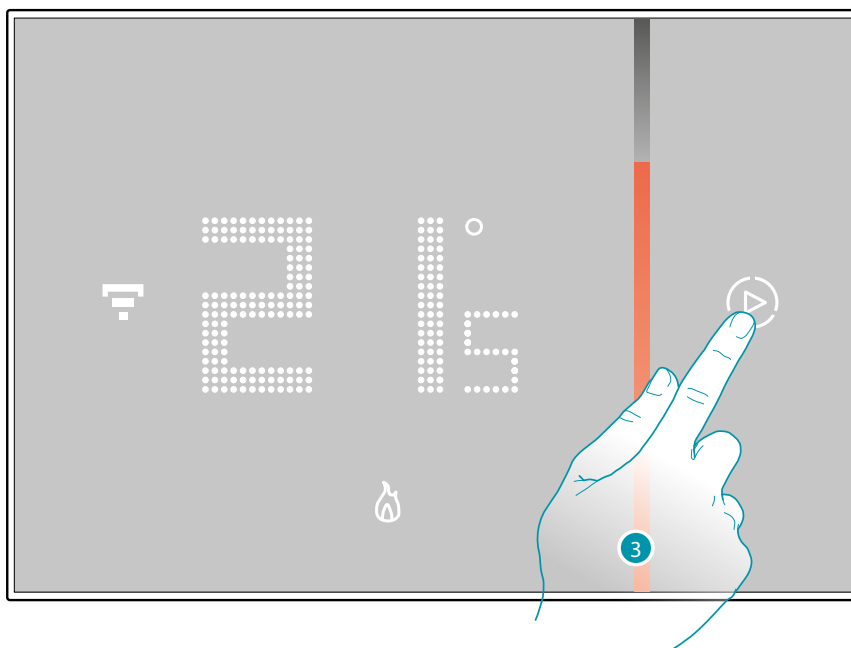

After setting the desired duration (30, 60 or 90 minutes) wait until the digits stop flashing after which the Boost mode will be activated.

The display shows the measured temperature; the LED gradually switches off while the set time passes by.



3. To end the setting early touch the  symbol; Smarter will continue operation according to the previous program.

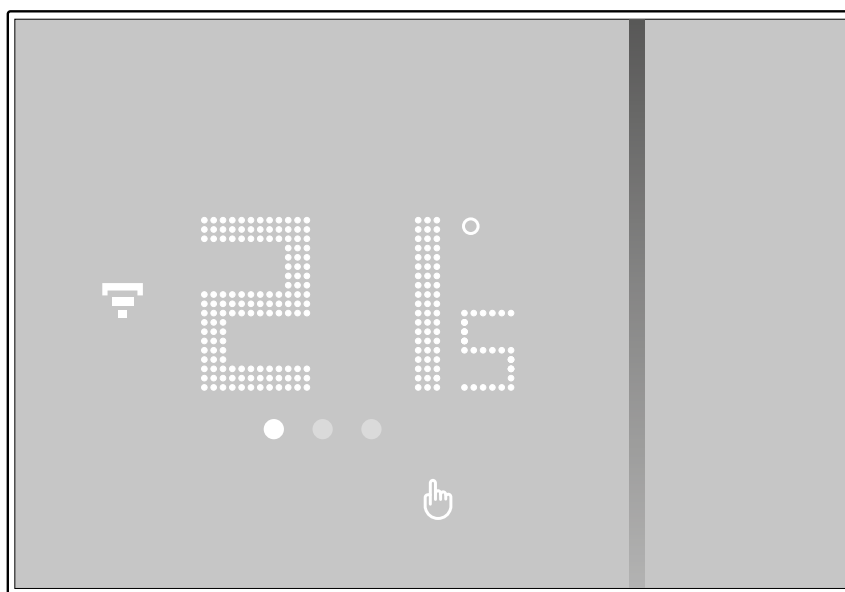

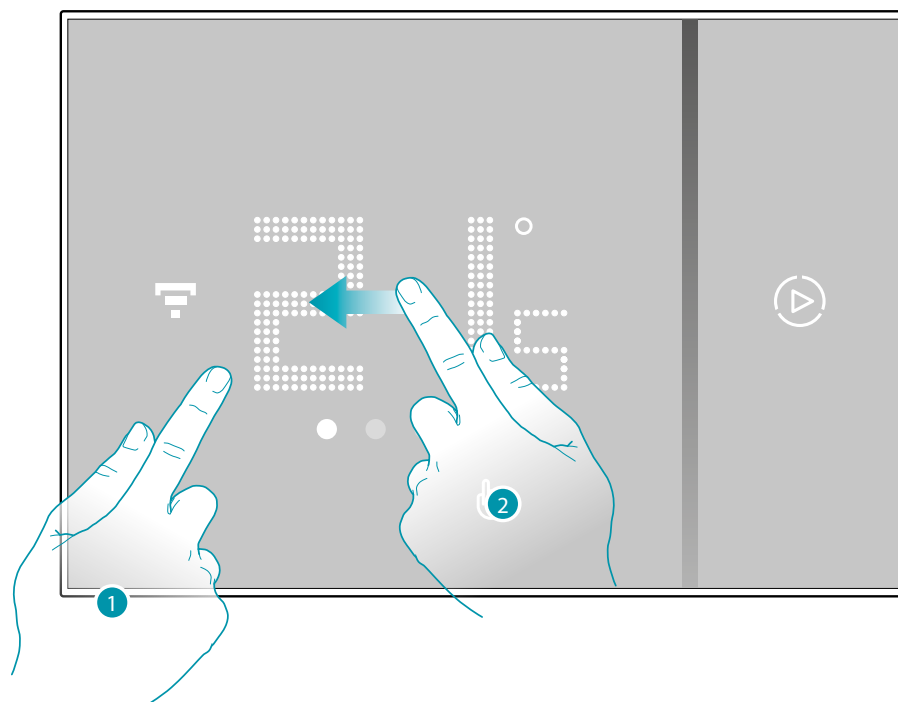

Set the temperature

The temperature level that can be locally set refers only to the manual mode operation.

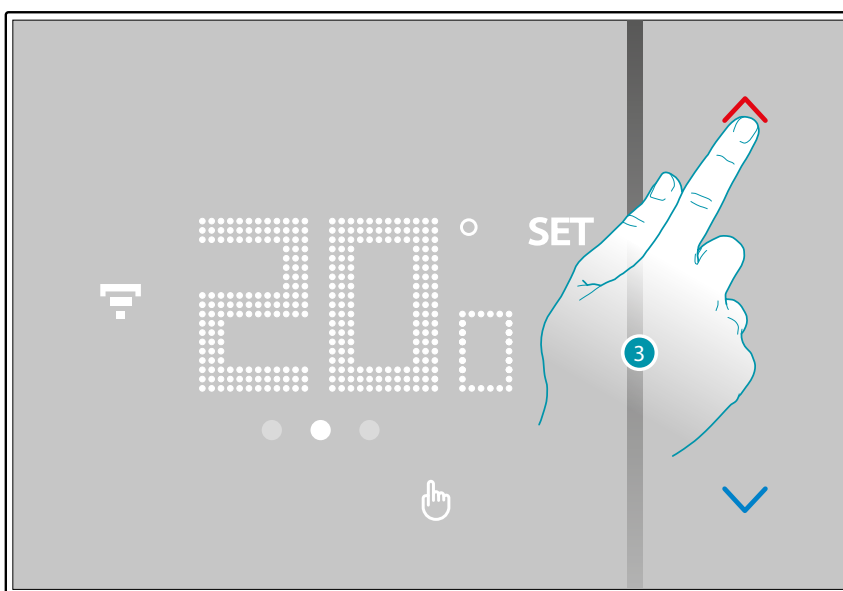

1. Touch the display
2. Scroll on the display to go to the next page



3. The current setting is displayed, change the setting with the  keys



Once the setting is complete wait for a few seconds. The display will show the measured temperature



Note: when the thermal (7 °C) protection temperatures are set, the display will show the switching-off symbol



Room humidity display

Smarter contains a sensor that detects the humidity percentage in the room; follow the procedure described below to display the measured value.

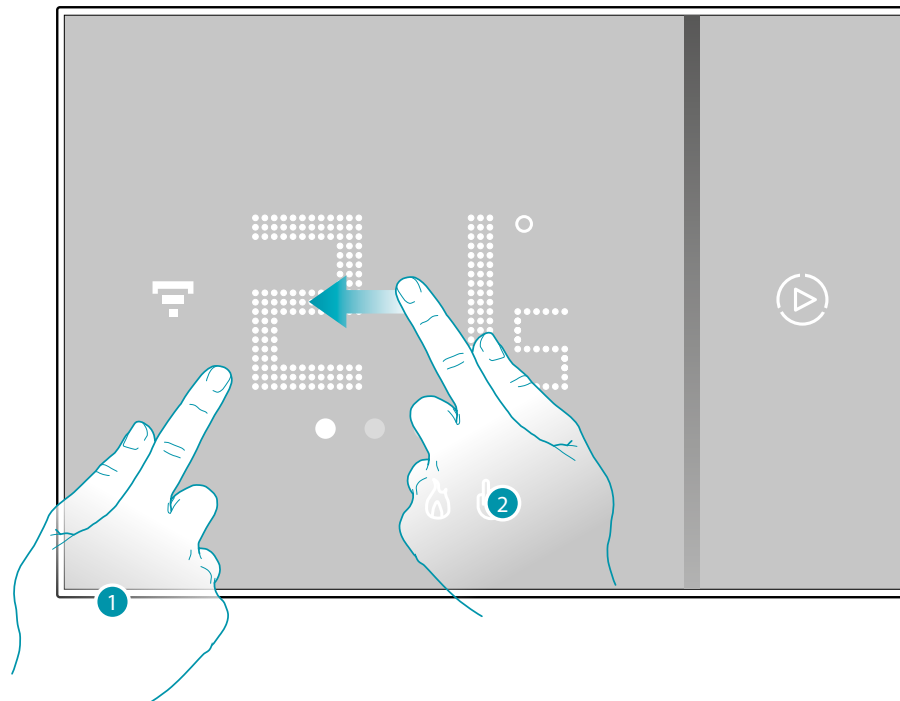

1. Touch the display
2. Scroll twice on the display to go to the dedicated page

The measured humidity percentage is visible for a few seconds, then the measured temperature display will appear again.

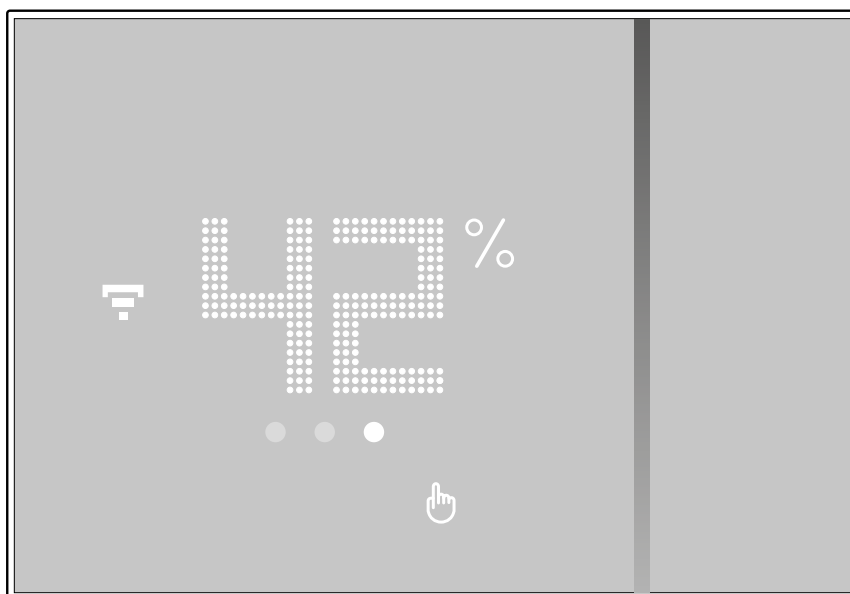

Control the Smarter with Home + Control app

Introduction

You can program the Smarter with the free Home + Control App. To do this you must:

1. Download the App from the Stores
2. Register and create an account
3. Associate the account to your Smarter via the App



Download the Home + Control app

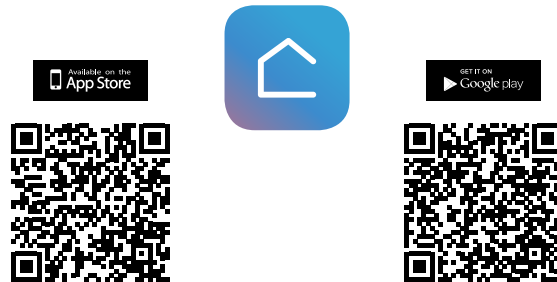

In order to remotely control your Smart system, first of all download the app from the Stores (for iOS® devices from App Store, for Android® devices from Play Store)



1. On your Smartphone run the app to read the QR codes and then frame the QR Code, or search for the Home + Control app in the stores.

Account registration

You must first register to be able to use the Home + Control App and thus use the Smarter advanced functions.

After opening the app follow the registration instructions:

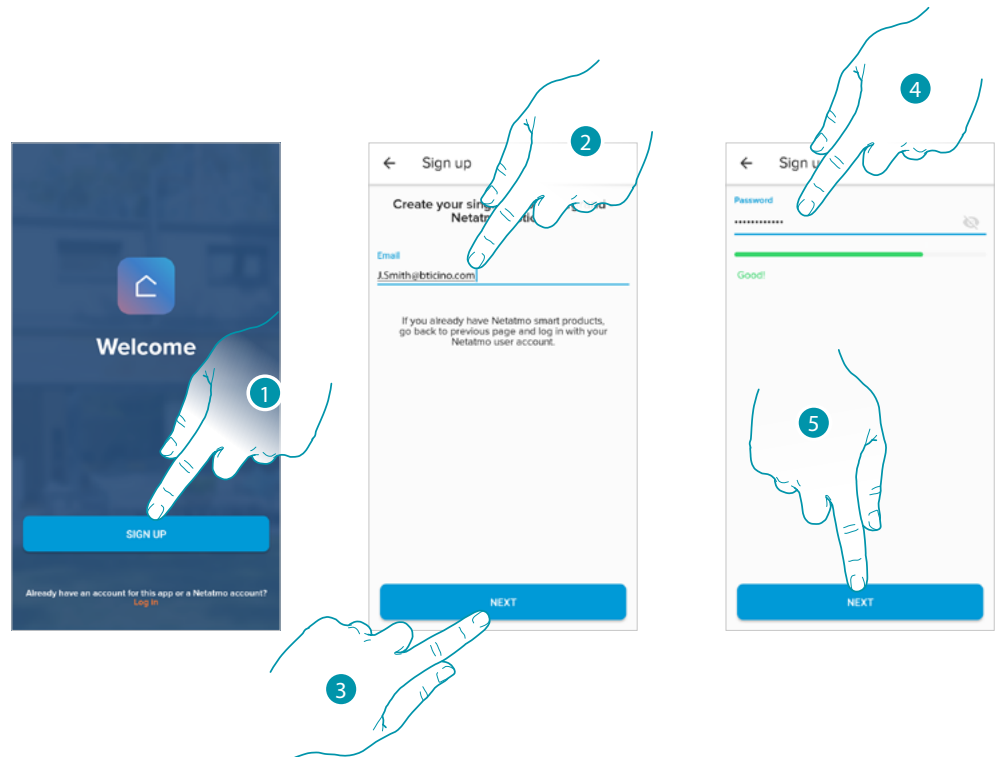

1. Touch to register and create an account otherwise use your credentials if you are already registered
2. Enter the email address that you want to use for the registration
3. Touch to continue
4. Enter a password, which must meet the following requirements:
 - at least 8 characters;
 - at least one lower case letter (e.g. a);
 - at least one upper case letter (e.g. A);
 - at least one number (e.g. 1);
 - at least one special character (e.g. \$);
5. Touch to continue

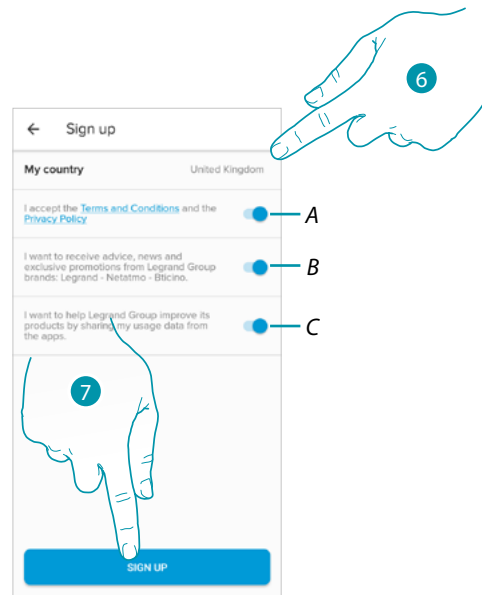

6. Select the country

A Touch to accept the terms and conditions of use laid down in the associated text (obligatory)

B Touch to enable the forwarding of news and promotions regarding Legrand group products

C Touch to help the Legrand group to improve its products

7. Touch to create an account

Preliminary operations for the use of a smartphone with iOS operating system

Before the association, prepare the HOMEKIT code to be scanned or note it down in the appropriate space.

You can find the HOMEKIT code:

- on the back of the instruction sheet

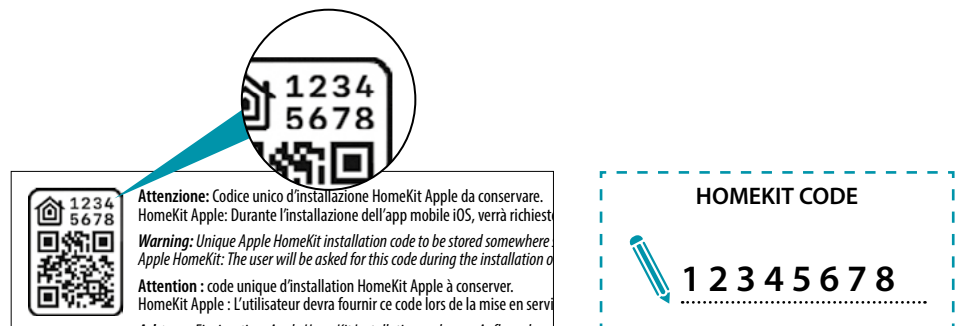

- on the protective film of the Smarter

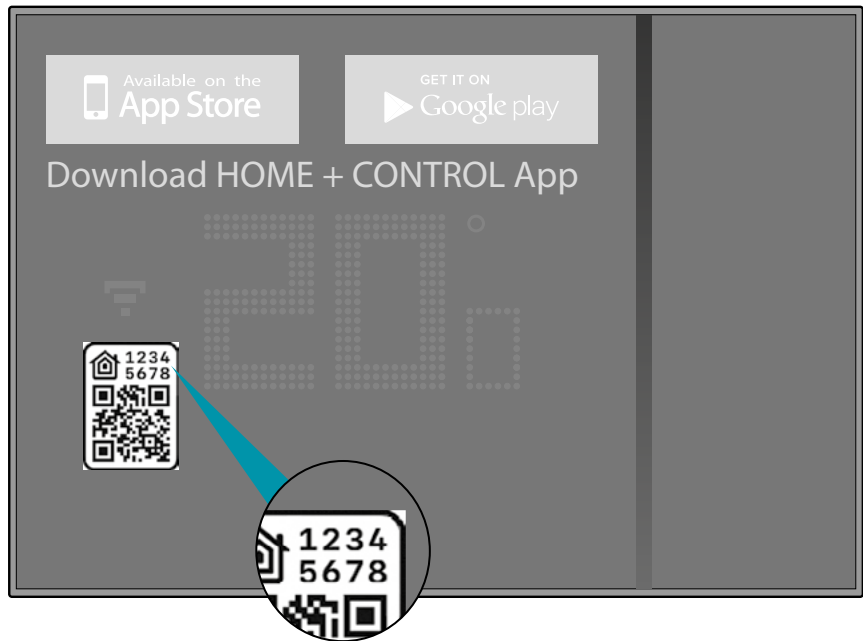

- on the back of the Smarter

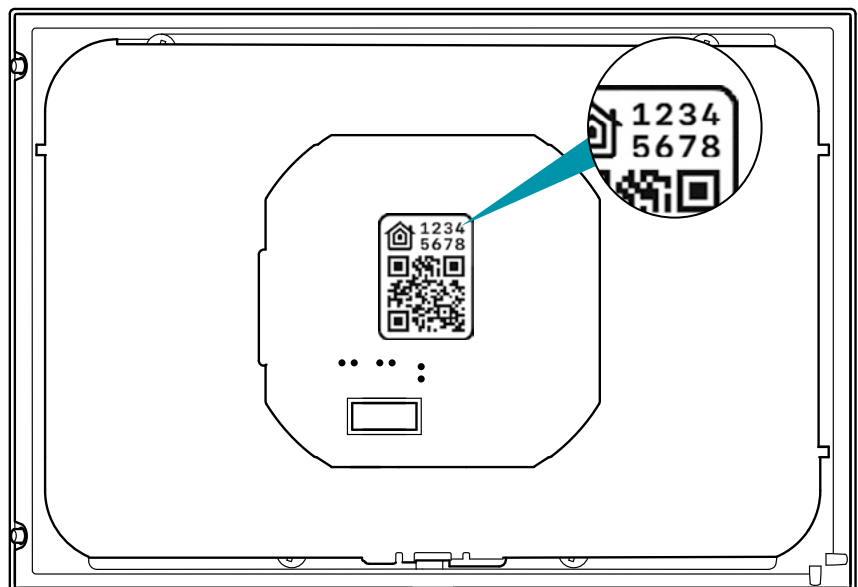

Associate the Smarter

At this point the system will show you a tutorial to help you associate to your Smarter.

Note: before starting the association with the system, establish the connection with the home Wi-Fi

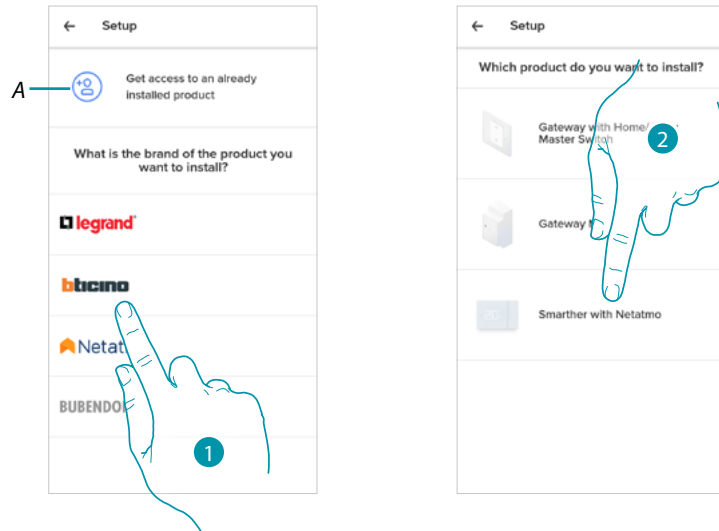

A Touch if you have been [invited to manage the home by a user](#)

1. Touch to select the brand of the product to install
2. Touch to select the Smarter

the configuration procedure differs based on the smartphone operating system:

- [if you use a smartphone with Android operating system](#)
- [if you use a smartphone with iOS operating system](#)

if you use a smartphone with Android operating system

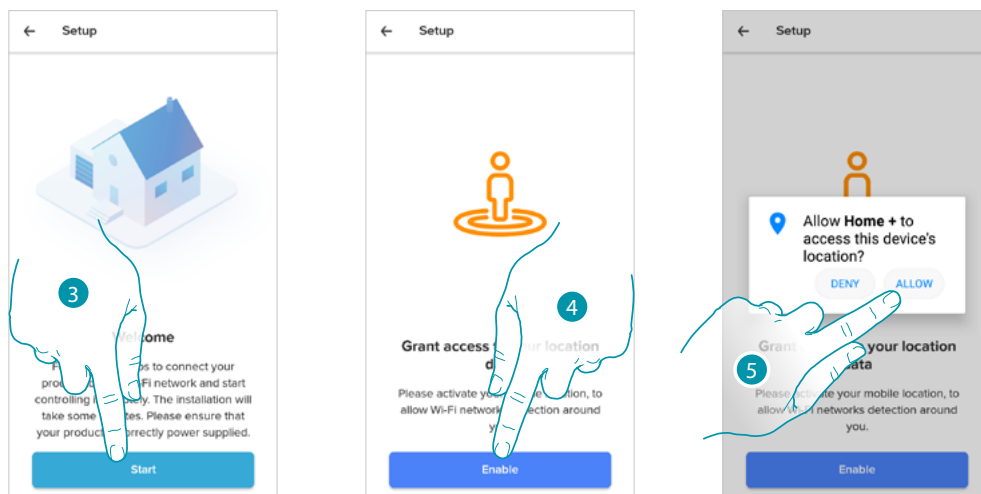

3. Touch to start the configuration
4. Touch to enable the device location
5. Touch to allow Home + Control to access the Smartphone position

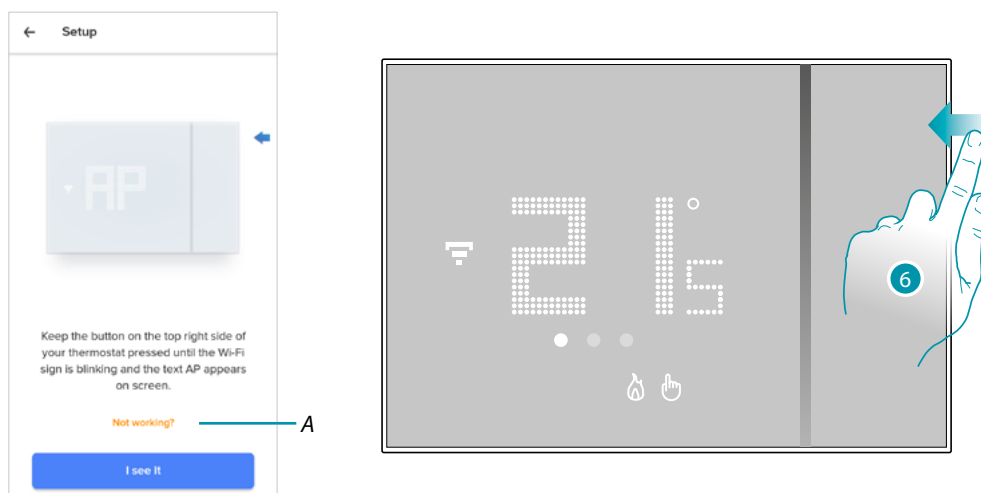

- A Opens the FAQ to help in the resolution of the problem*
6. Keep the upper Smarter pushbutton pressed until "AP" appears

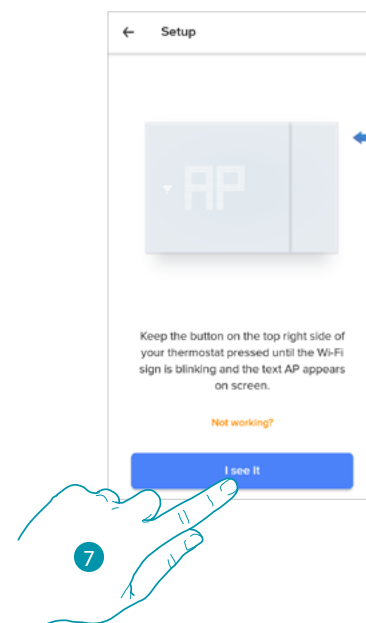

7. Press to continue

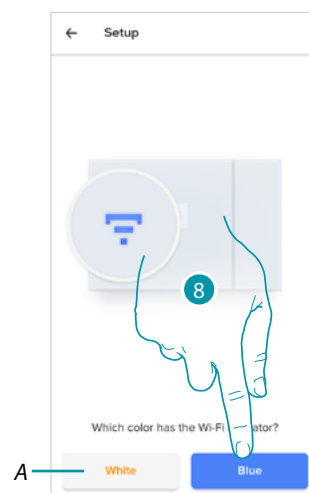

8. The Smarter shows the blue Wi-Fi symbol. Touch it to continue the configuration

A Indicates that you are trying to complete the association using an incorrect App

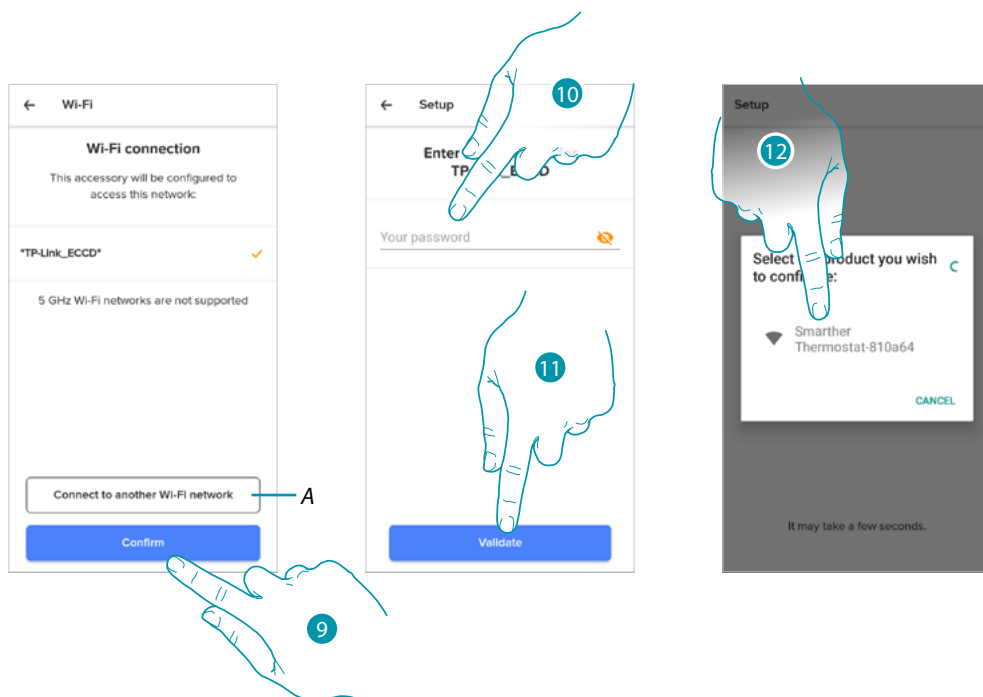

9. Touch to confirm the suggested home Wi-Fi network, otherwise touch (A) to select a different one
10. Enter the home Wi-Fi password
11. Touch to continue
12. Select the Smarter

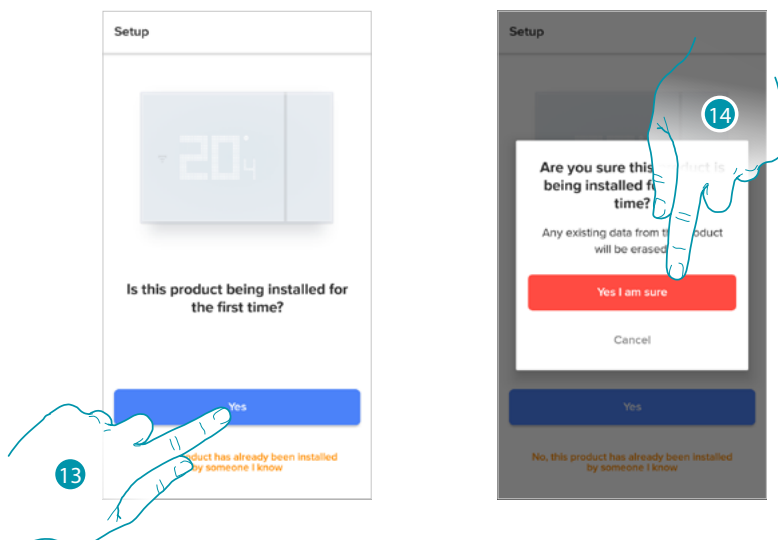

13. Touch if this is the first Smarter installation
 14. Touch to confirm that this is the first installation
- Caution: all the existing data will be deleted*

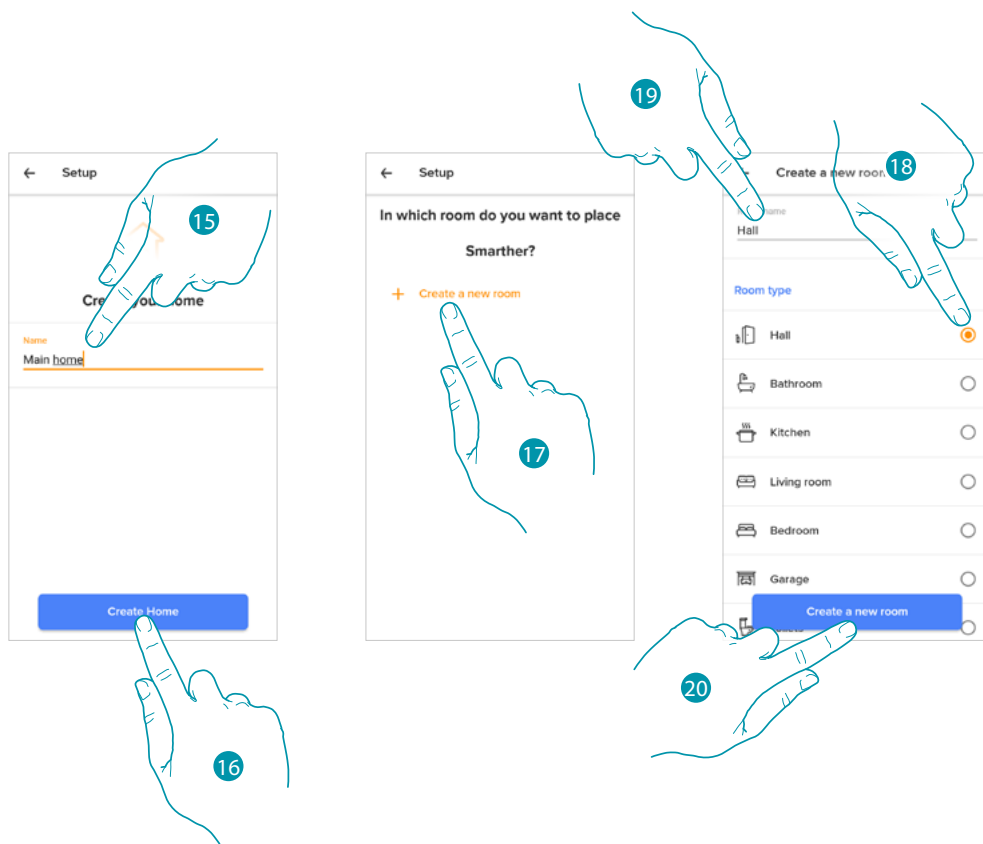

15. Enter a name for the home
16. Touch to create a new Home + Control home
17. Touch to create a new room
18. Select the type of room where the Smarter has been installed
19. If necessary touch to rename the room
20. Touch to confirm

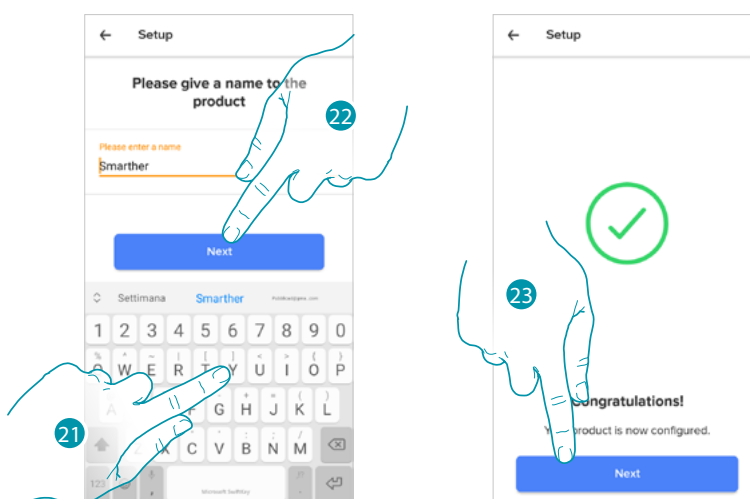

21. Customise the Smarter name
22. Touch to confirm
23. The Smarter is configured correctly; touch to create a program using the [guided procedure](#) (the same for both Android and iOS systems)

If you use a smartphone with iOS operating system

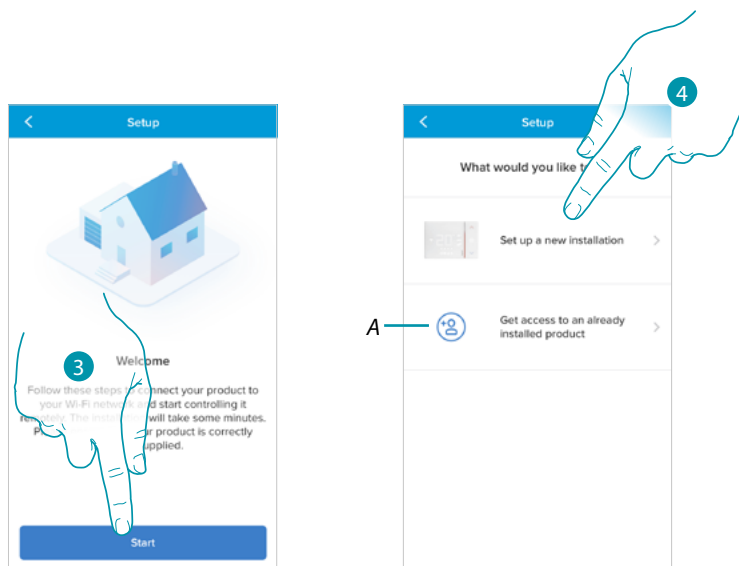

3. Touch to start the configuration
 4. Select to complete a new installation
- A Touch if you have been *invited to manage the home by a user*

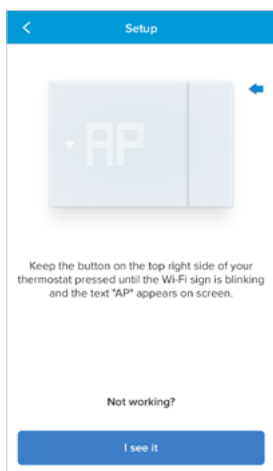

5. Keep the upper Smarter pushbutton pressed until "AP" appears

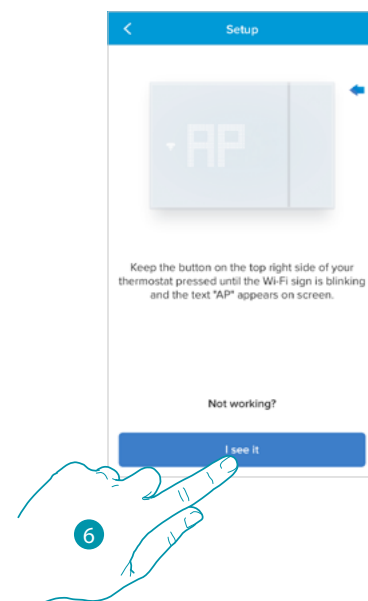

6. Press to continue

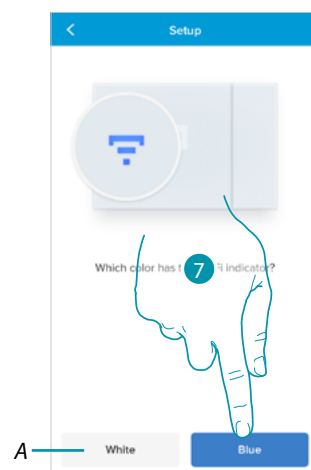

7. The Smarter shows the blue Wi-Fi symbol. Touch it to continue the configuration
A Indicates that you are trying to complete the association using an incorrect App

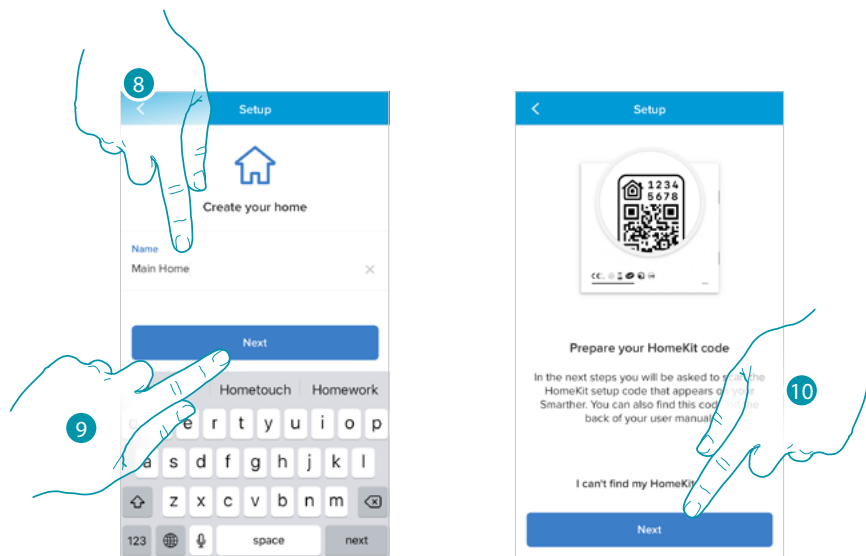

8. Enter a name for the home

9. Press to continue

Prepare the HOMEKIT code (see [Preliminary operations for the use of a smartphone with iOS operating system](#))

10. Press to scan the HOMEKIT code



11. Scan the HOMEKIT code

Or

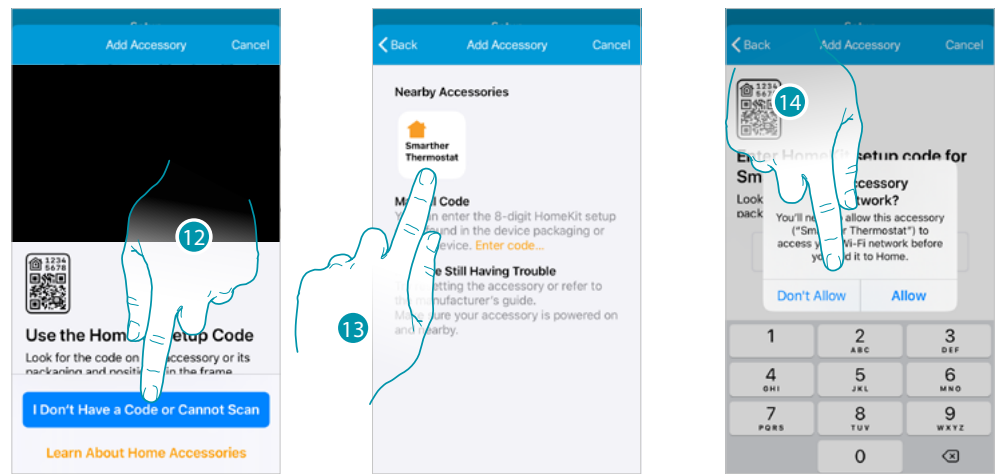

12. If the code is not detected automatically, or if it cannot be scanned, touch to open the manual entry page

13. Touch the Smarter detected nearby

14. Touch to allow the Smarter to access the Wi-Fi network

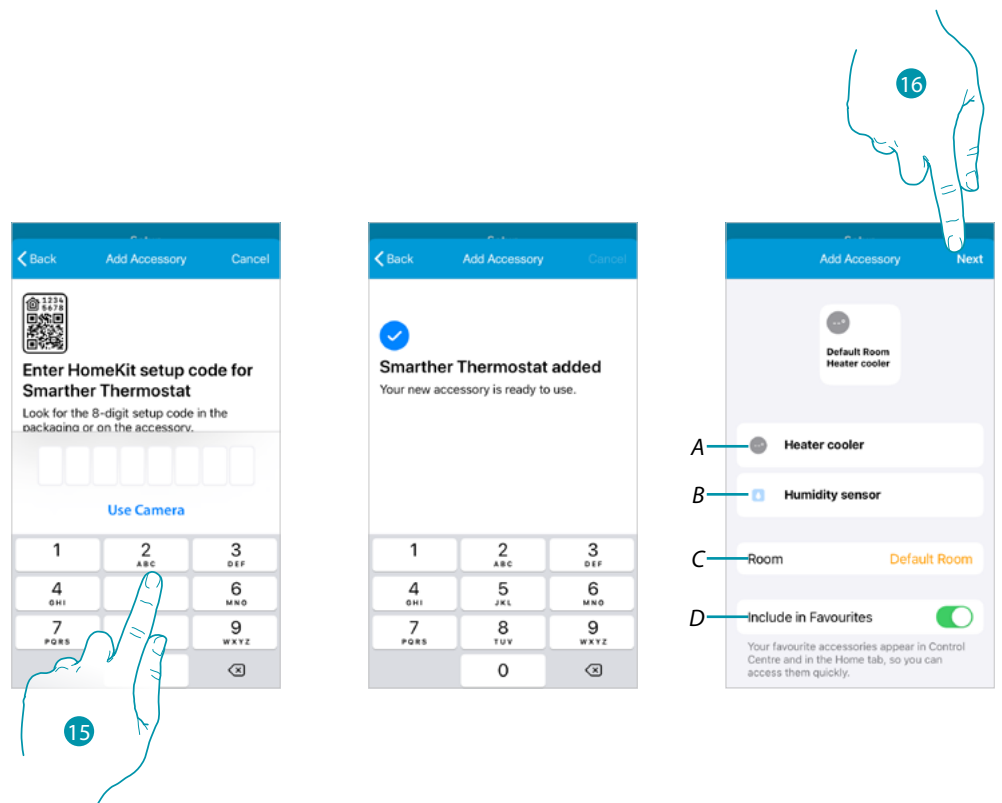

15. Manually enter the HOMEKIT code

A Rename the Smarter for the heating function

B Rename the Smarter for the humidity detection function

C Select the room/create a new one where to insert the Smarter within the HOMEKIT App

D Add/remove from favorites

16. Touch to continue



- 17. Touch to select the scenarios where you want to include the Smarter
- 18. Touch to continue.
- 19. Touch to end the configuration of the HOMEKIT App
- 20. Touch if this is the first Smarter installation

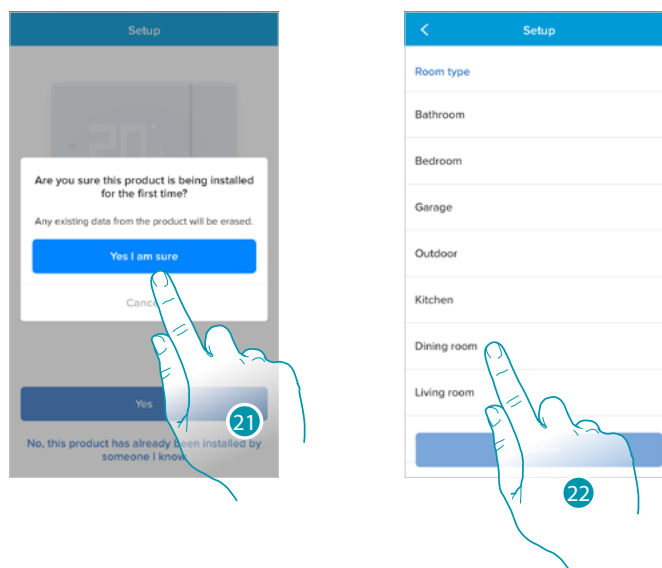

- 21. Touch to confirm that this is the first installation
- 22. Touch to select the type of room where to install the Smarter

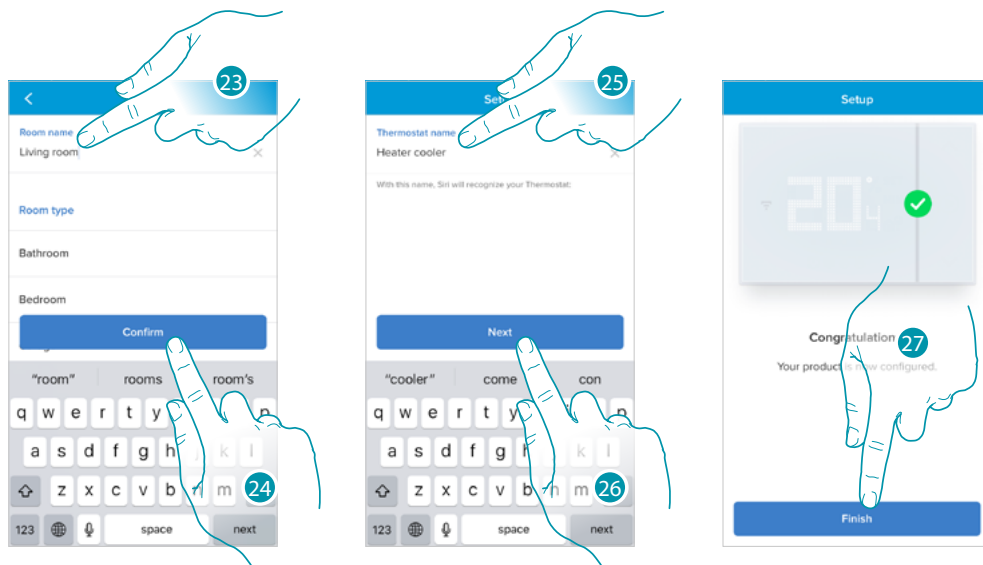

- 23. If necessary touch to rename the room
- 24. Touch to confirm
- 25. Customise the Smarter name
- 26. Touch to confirm
- 27. The Smarter is configured correctly; touch to create a program using the [guided procedure](#) (the same for both Android and iOS systems)

Create a program using the guided procedure

At this point, through questions you have to answer, the procedure proposes to create a program to adjust the temperature.

It is possible to learn more about the program operation in the [Schedules](#) chapter

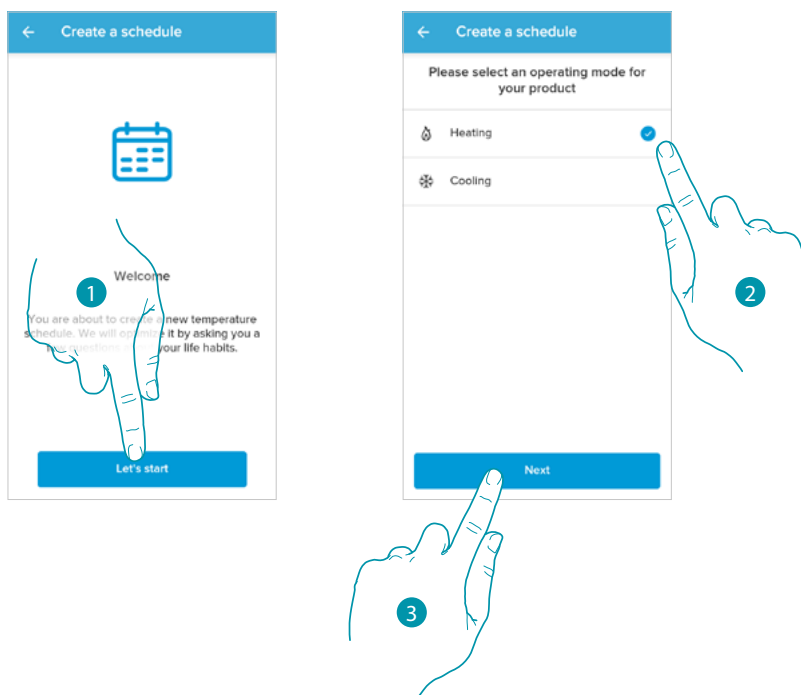

1. Touch to start the guided procedure
2. Select if the program is for a heating or a cooling system
3. Touch to continue

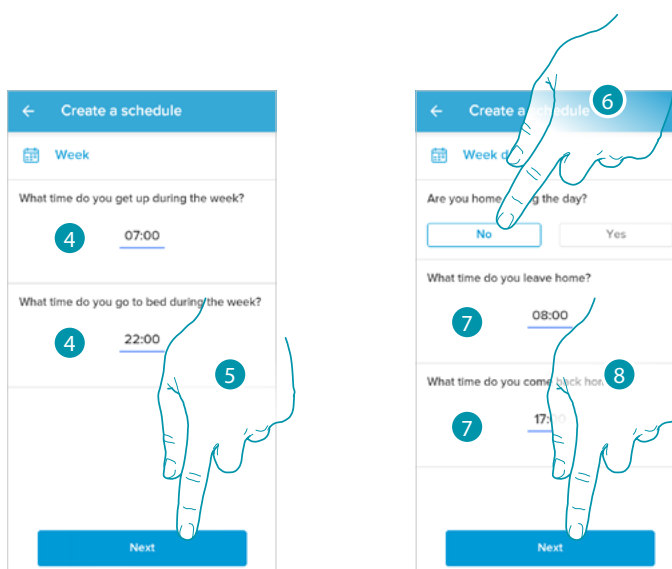

4. Set the time interval time limits (when you get up and when you go to bed during the week)
5. Touch to continue.
6. Select if during the day you are at home or not.
7. Set the times which delimit the time intervals
8. Touch to continue.

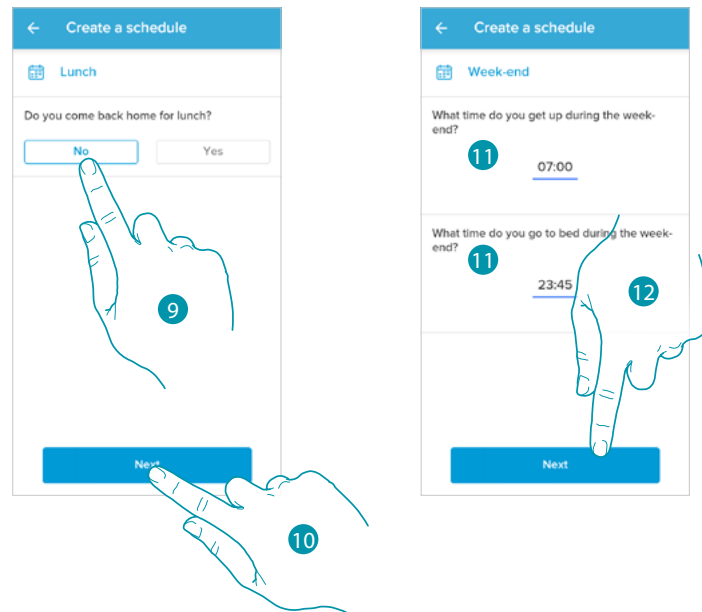

- 9. Select if during the week you normally come back home for lunch or not.
- 10. Touch to confirm
- 11. Set the time interval time limits (when you get up and when you go to bed during the weekend)
- 12. Touch to continue.

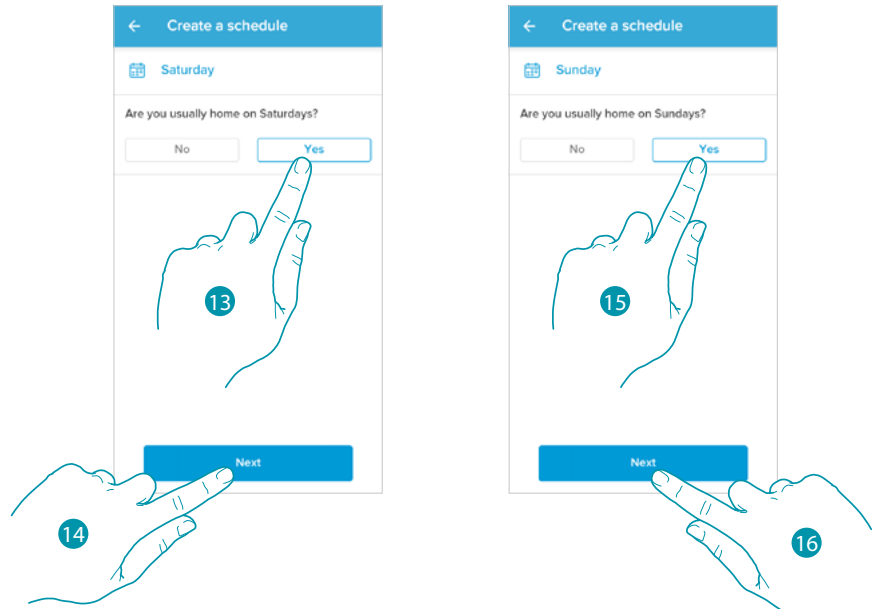

- 13. Select if you are normally home on Saturday or not.
- 14. Touch to continue.
- 15. Select if you are normally home on Sunday or not.
- 16. Touch to continue.

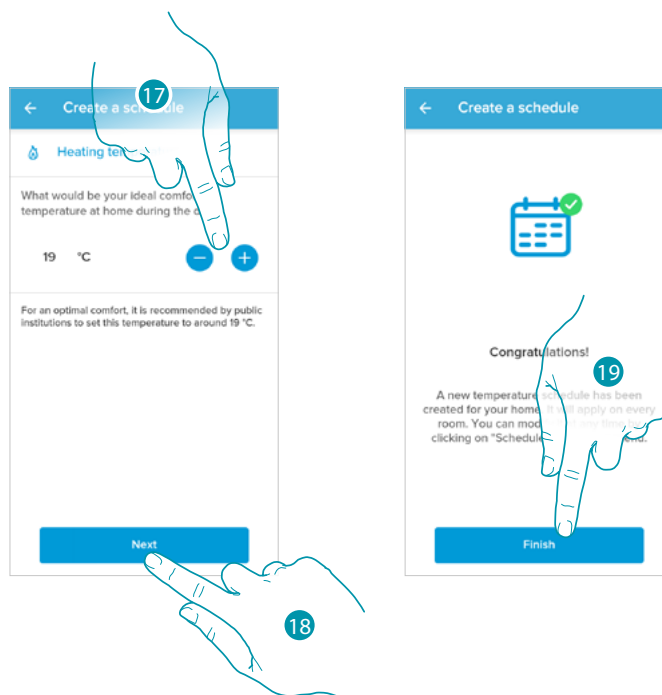

17. Select a temperature that you consider comfortable when you are at home during the day.

18. Touch to continue.

19. Touch to end, the [Home Page](#) appears

Access your home through invitation

You can access the Smart system created by your installer, or one of your family members, following the steps shown below.

Note: all the users have the same control, invitation and modification authorities.

- [Download the app from the Stores](#)
- [Register and create an account](#)
- **Accept the invitation** sent by email by your installer or family member
- **Access the App** with the credentials just created
- **Control your Smart system** with the app

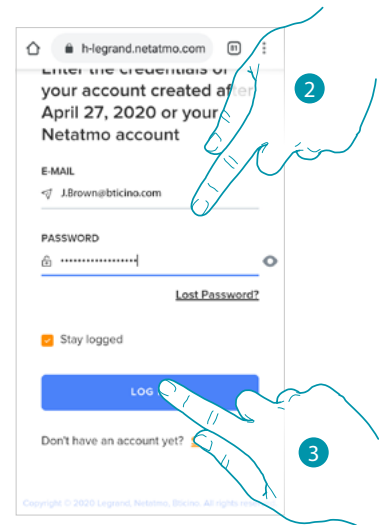
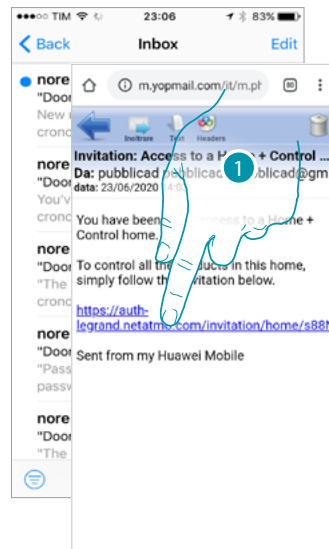

1. Touch the link in the email received from the system following an invitation
2. Enter your registration details
3. Touch to access

A message and an email will confirm that the invitation has been accepted. Open the App and enter the authentication data

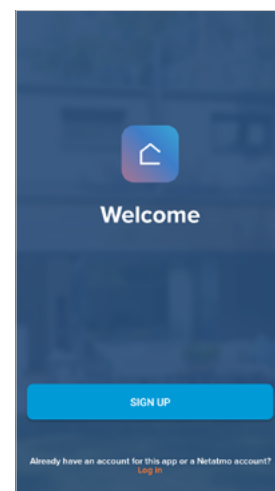
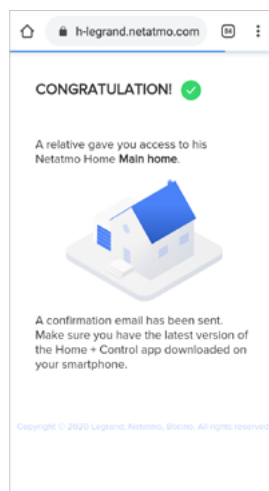

Forgotten password

When you have forgotten the password:

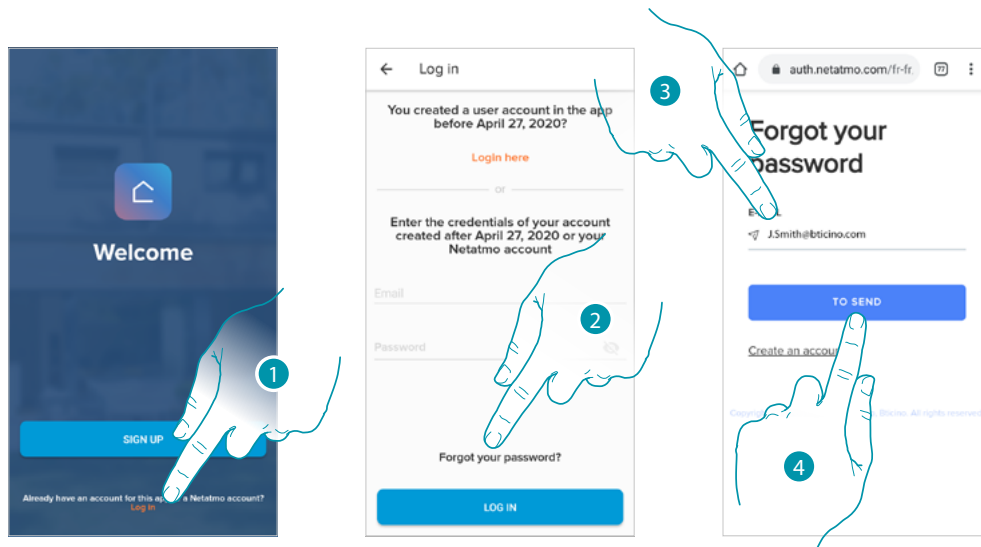

1. Touch to open the login page
2. Touch to activate the password recovery procedure
3. Enter the email address, to which the system will send the link for changing the password
4. Touch to send a link

After confirming, the system will send the link to modify the password to the email address that you have indicated

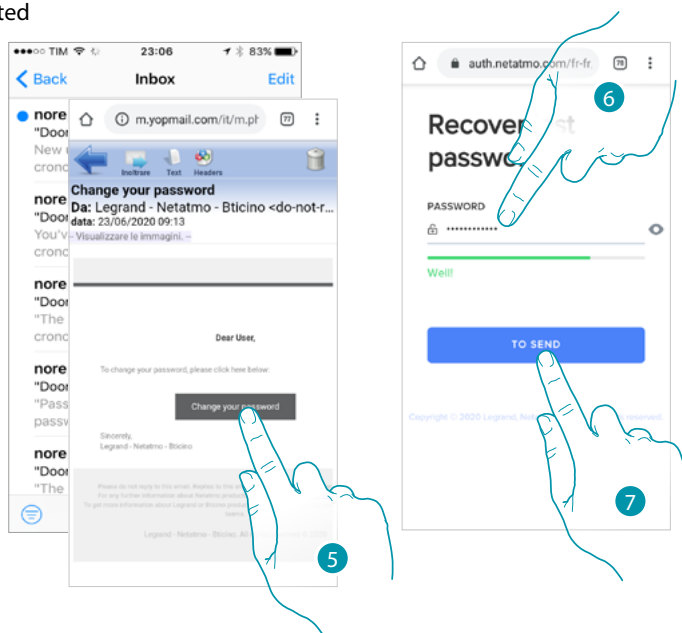

5. Touch to modify the password
6. Enter the new password, which must meet the following requirements:
 - at least 8 characters;
 - at least one lower case letter (e.g. a);
 - at least one upper case letter (e.g. A);
 - at least one number (e.g. 1);
 - at least one special character (e.g. \$);
7. Touch to confirm

A message will confirm that the password has been changed successfully; open the App to insert the authentication data

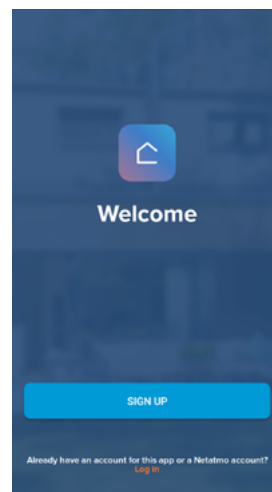
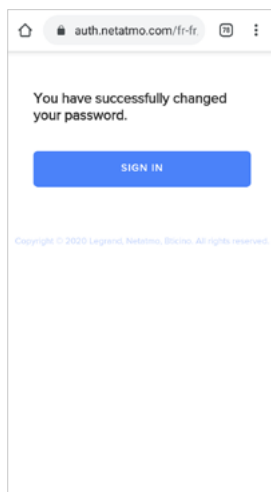

Authentication

After registering with the portal, you can authenticate by entering email and password.

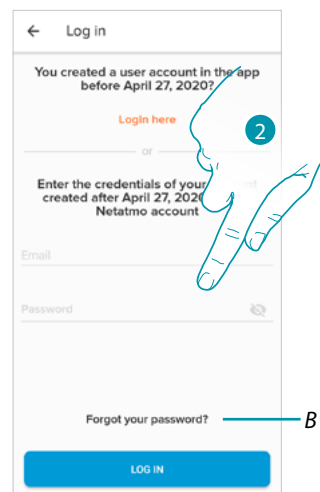
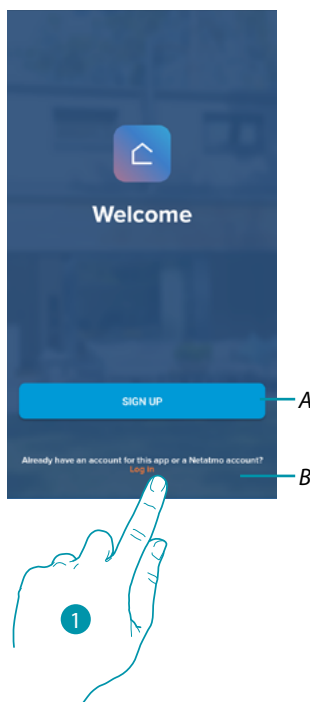

- A Touch to create a [new account](#)
- 1. Touch to open the login page
- 2. Enter email and password
- 3. Touch to access
- B Touch to start the [password recovery](#) procedure

Home Page

After logging in, from this page you can manage the temperature inside your home, using the Smarter and/or the Netatmo valves.

The elements displayed in the Home Page depend on your home setup, for example split into rooms, with a device for every room, or several devices in the same room, and therefore the temperature management controls available; there are in fact:

- Controls for single device
- Room controls
- Home controls

The sample Home Page below shows one single device in a single room



- A Home name/display homes
- B It opens the "Graphic" section where it is possible to view your heating system consumptions
- C Measured temperature and measured humidity percentage
- D Heating or cooling contact switched
- E Set temperature
- F Set the "Boost" function
- G Set the Temperature
- H Schedules and selection of absent, frost guard, program change function)
- I Display the currently active Smarter functions



[Program in progress](#)

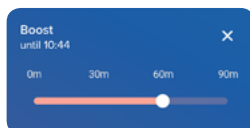

[Boost functions](#)

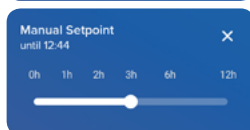

[Manual Function](#)











[Frost guard Function](#)



[Absent Function](#)

- L Settings pull-down menu

	Manage my home	It opens a section where it is possible to change some settings regarding the individual rooms and devices, or the settings of the whole home. It is also possible to set some Smarter parameters
	Schedules	It opens the section, where it is possible to create and manage the programs
	Thermal comfort	It opens the section, where it is possible to manage some Smarter parameters
	Manage my guests	Open the section where you can display those users which can interact with your Smarter, invite new ones or if necessary delete them.
	Add a product to this home	It opens the section where it is possible to add devices connected to your system.
Advanced		
	Install a new home	It opens the section where it is possible to install a new home associated with your account (e.g. mountain home)
	Help	It opens the section where it is possible to display FAQ (and their answers) regarding the use of the Home +Control app.
	My account	It opens the section where it is possible to view your account, and change the password
	Logout	Logout from the Home + Control app

Control a single device

It is possible to set the temperature and activate boost operation. The settings will only affect the device inside the room

Set the temperature

This function allows to set a temperature

A visual and text indication will indicate the remaining time.

You can also modify the setting before the end via the function.



1. Touch to set the temperature
2. Scroll to set for how long it should be maintained (default 3 hours, maximum 12 hours)

The temperature is now set

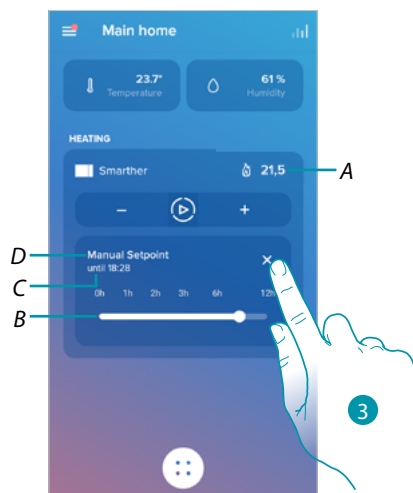

- A Set temperature
 - B Time indication bar: it indicates the remaining time in a chart format
 - C Setting end time
 - D Set mode indication
3. Touch to quit the current mode and return to the programmed mode

Decreasing the temperature below 7.5 °C will cause the activation of the Frost guard function, which on a heating system only allows to keep a minimum safety temperature.

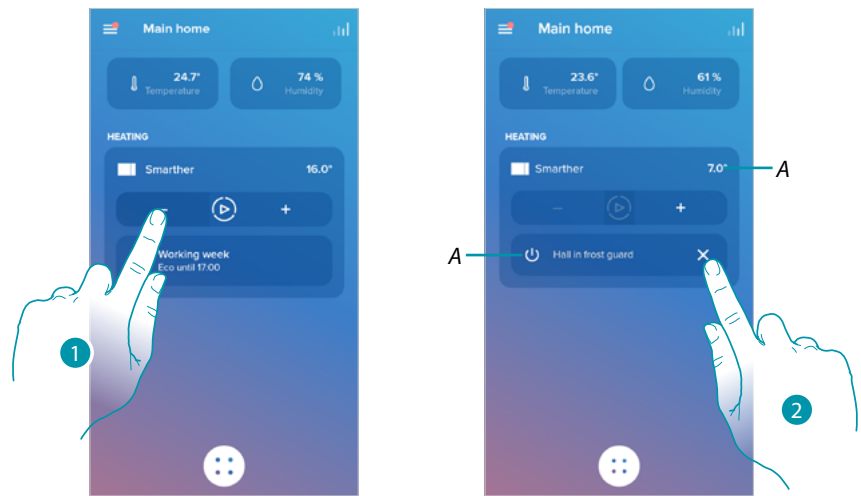

1. Touch until the indication of the set temperature falls below 7.5 °C

The function is now set

A Set mode indication

2. Touch to switch the device back on

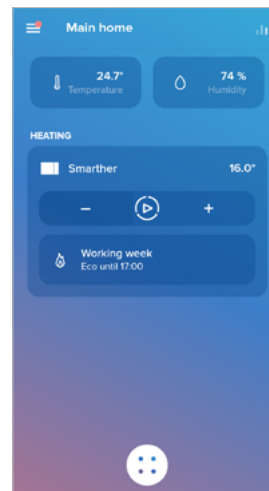

Set the Boost function

This function forces the switching on of the system (both heating and cooling) for a limited time (30, 60 or 90 minutes) independent of the measured or programmed temperature. Once the time set has elapsed, the Smarter will resume operation according to the previous program.

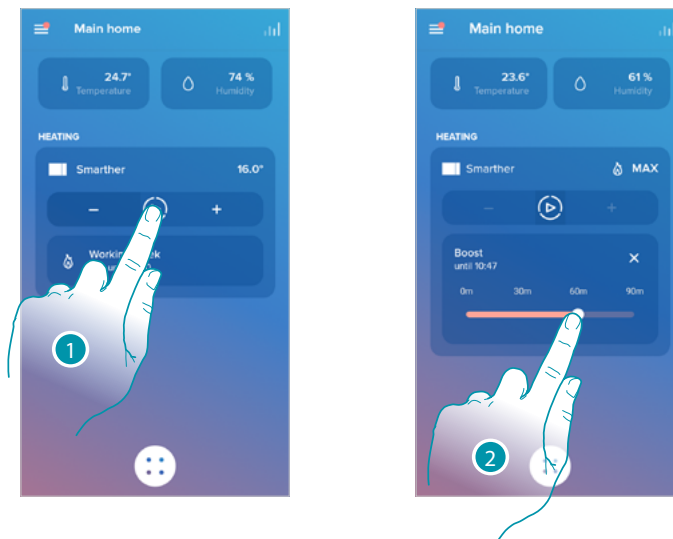

1. Touch to set the function
 2. Scroll until reaching the desired time among 30, 60 and 90 minutes (default 90 minutes)
- The function is now set



- A Set mode indication
 - B Time indication bar: it indicates the remaining time in a chart format
 - C Setting end time
 - D Set mode indication
3. Touch to quit the current mode and return to the programmed mode

Control all the devices in the room

Control all the devices in the room

It is possible to set the temperature and activate boost operation. The settings will affect all the devices in the room, or select a program for the whole home.

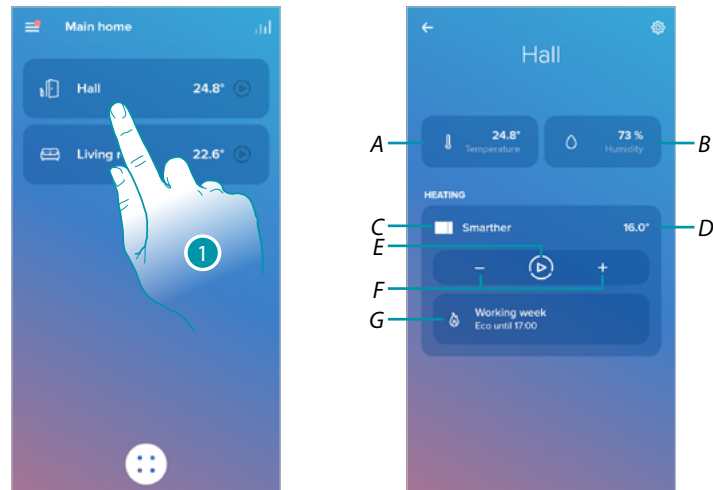

1. Touch to manage the room temperature

A Temperature measured in the room.

B Measured humidity percentage

C Indication of the number and the types of devices in the room

D Temperature set in the room

E Set the [Boost function](#) for the whole room

F Set the [Temperature](#) in the room

G It opens the [Programs](#) section where it is possible to manage the schedules for the whole home

Note: in case of need to individually adjust the temperature for each room device, it will be necessary to create additional rooms and enter a device for each of them.

For example, it is possible to use the room creation tool to create "living room - south" and "living room - north", enter a Netatmo valve in each one, and manage them separately.

Control all the home devices

Using the home page central button, it is possible to adjust the temperature of the home, sending commands that will affect all the devices.

You can therefore activate the Frost guard Function, the "Absent" function or a program for all the home devices

Absent Function

This setting allows to enable the "Absent" function on the Smarter (temperature 12°C).

The Absent function is very useful when going out for a medium-long period of time and it is necessary to keep an acceptable temperature, avoiding pointless energy waste.

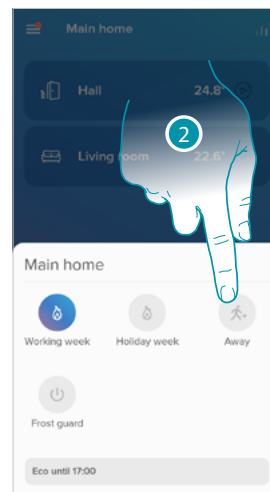
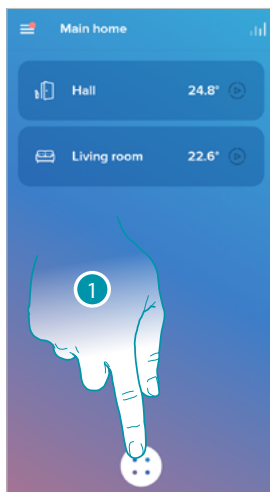

1. Touch to access the Schedules section
2. Touch to set the "Absent" function

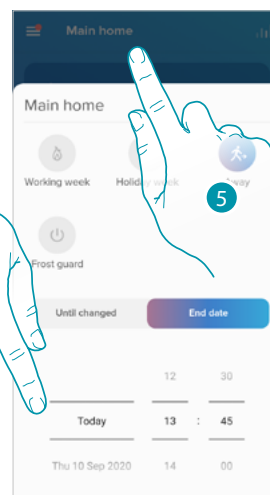
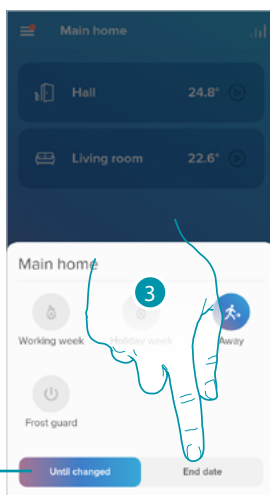

A

- A Touch to set the devices in Absent mode until you change the setting manually.
3. Touch to select a date and time for the end of the "Absent" function
4. Select until what day and time the "Absent" function should remain active
5. Touch to confirm

The "Absent" function is now active on all the home devices

Frost guard Function

This setting allows to enable the “Frost guard” function (temperature 7°C).

The Frost guard function is very useful when going out for a medium-long period of time and it is necessary to keep a temperature that will prevent problems in the home system.

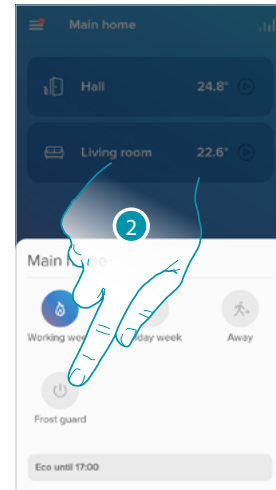
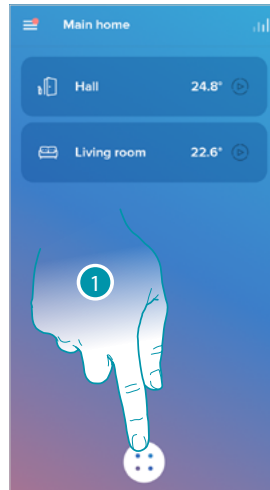

1. Touch to access the Schedules section
2. Touch to set the “Frost guard” function

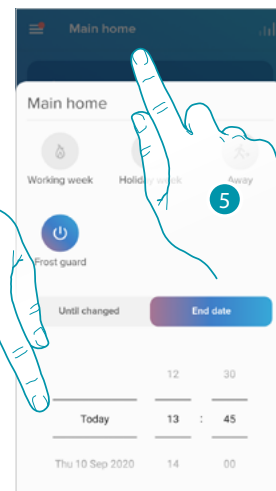
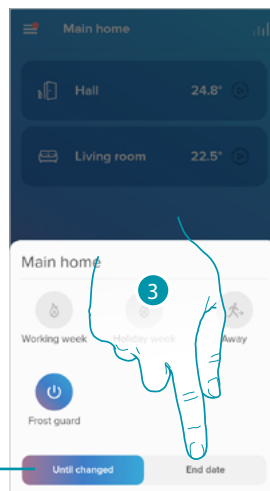

A

- A Touch to set the devices in frost guard mode until you change the setting manually.
3. Touch to select a date and time for the end of the “Frost guard” function
4. Select until what day and time the “Frost guard” function should remain active
5. Touch to confirm

The “Frost guard” function is now active on all the home devices

Set a program for all the home devices

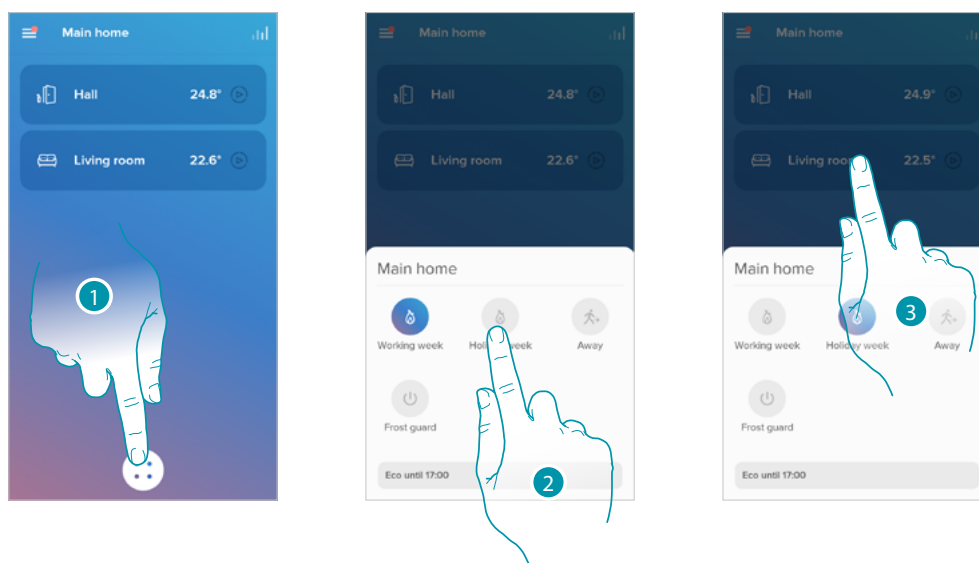

1. Touch to access the Schedules section
2. Touch to select a program among the ones available
3. Touch to confirm

The selected program function is now active on all the home devices
 To create or manage new programs, see [Schedules](#) chapter.

Settings

Manage my home

In this section it is possible to change the settings of the individual rooms and devices, or the whole home. It is also possible to set some parameters of the devices inside the home.

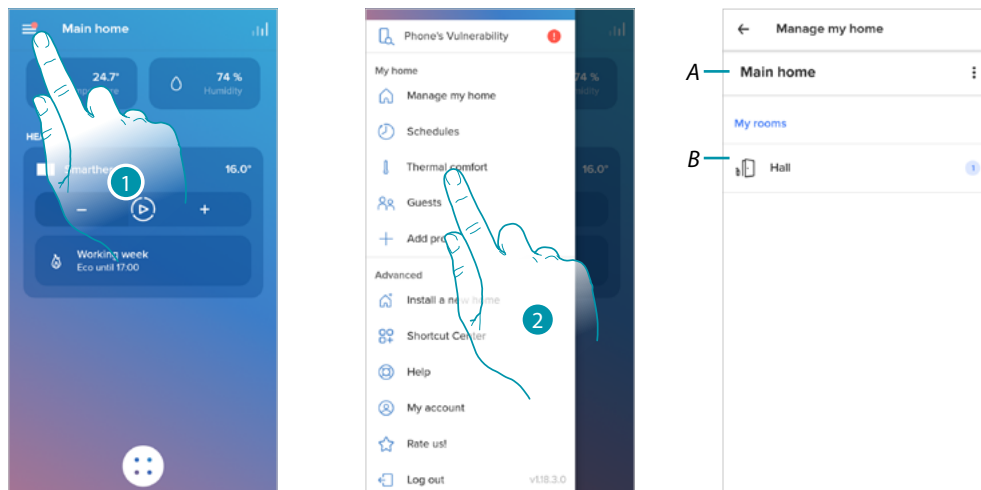

1. Touch to open the Settings menu
 2. Touch to access the home management page
- A It opens the [Home parameters](#) section
- B Opens the [Room settings](#) and device settings section. ([Smarter/Valves](#))

Home parameters

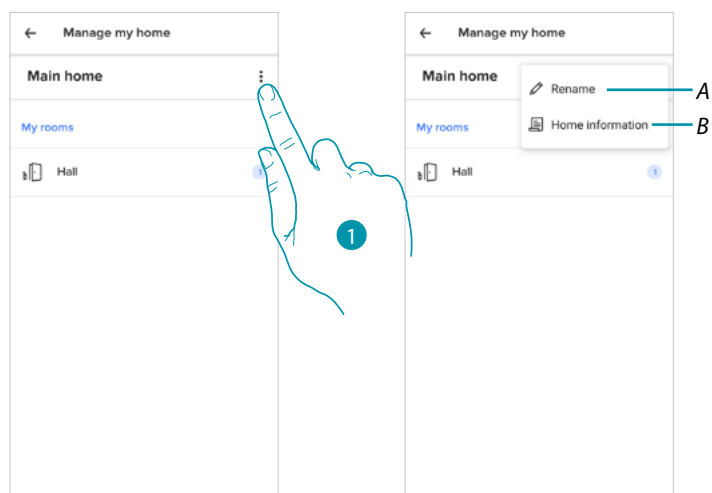

1. Touch to access the home parameters
- A A Touch to change the home description
- B Set advanced parameters as [Location](#), [Time zone](#), [Energy source](#), [Home type](#) and [Home dimension](#).

Advanced settings

In this section it is possible to set the geographical position of your home, the reference time zone, the energy source used for your home, the home type and its size.

Location

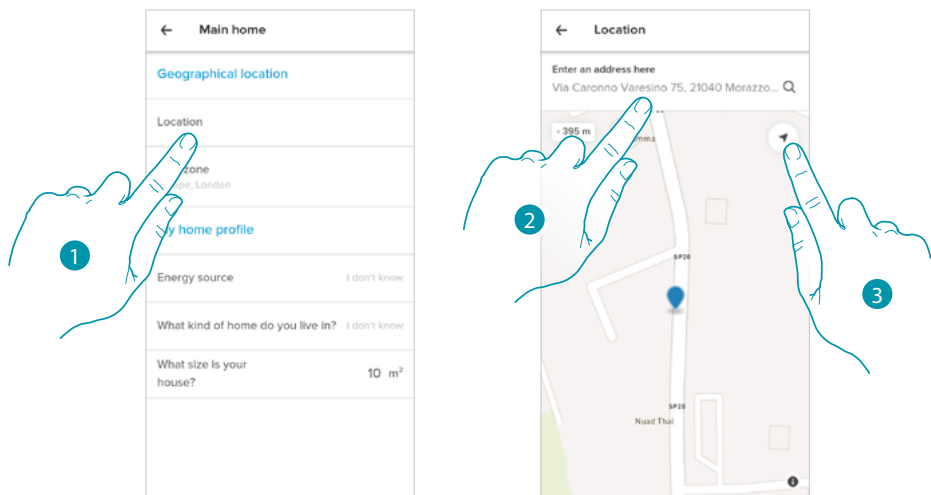

1. Touch to set your home position
 2. Enter the address and select it among the suggested ones
- Or
3. Touch to enable the automatic geolocation

Time zone

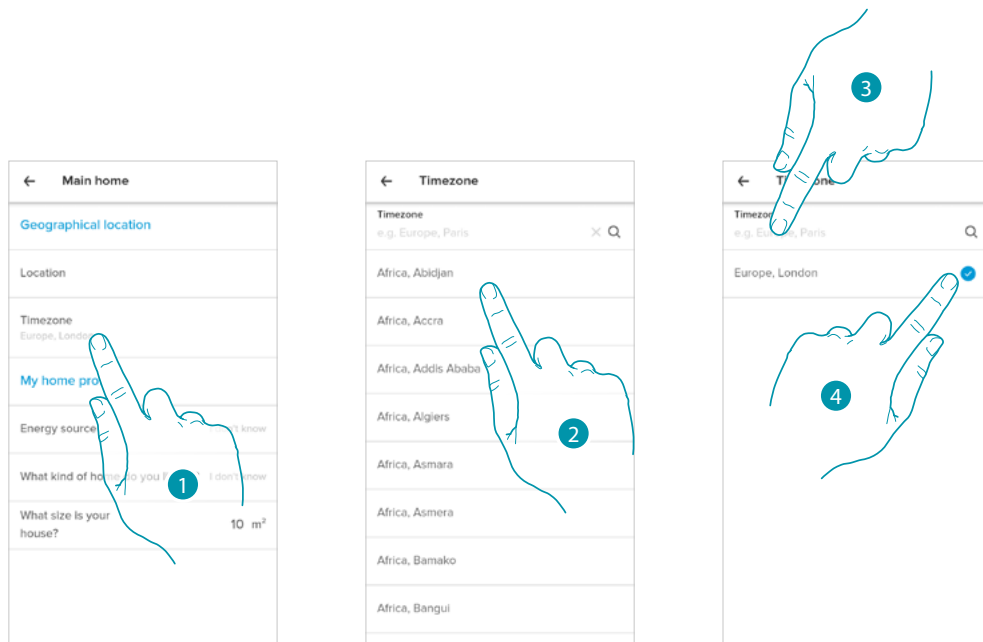

1. Touch to set the reference time zone.
 2. Scroll the zone list
- Or
3. Enter the zone
 4. Touch to select

Energy source

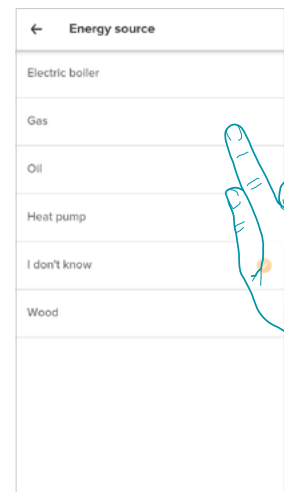
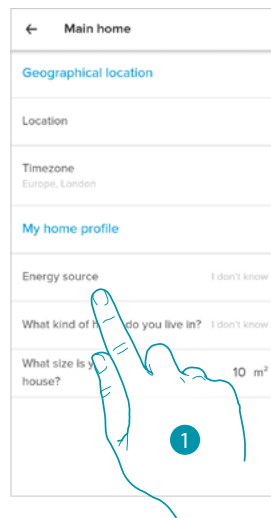

1. Touch to select the energy source to use for your home
2. Select the energy source among:
 - Electric boiler;
 - Gas;
 - Oil;
 - Heating pump;
 - Wood;

Home type

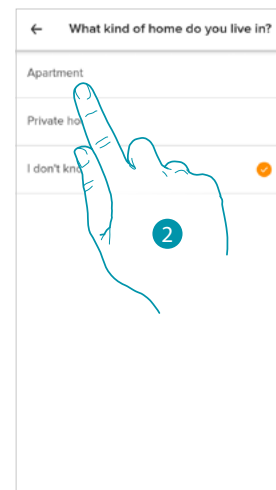
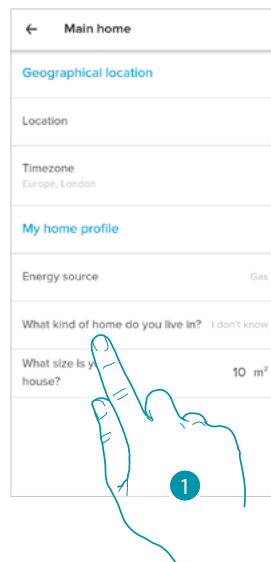

1. Select the type of home in which you live
2. Select the type among:
 - Apartment;
 - Single home;

Home dimension

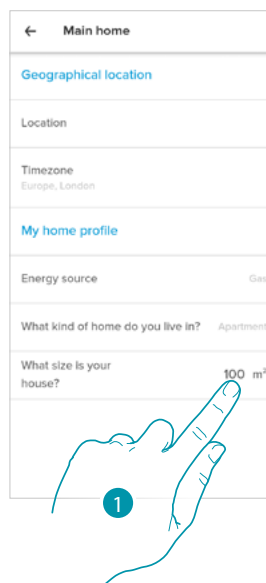

1. Enter your home dimension

Room settings

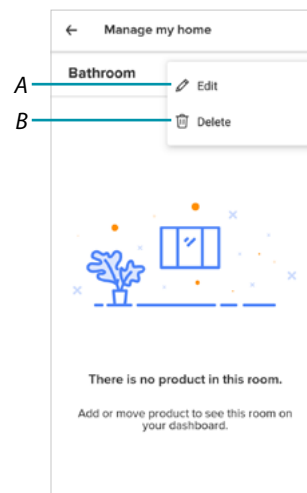
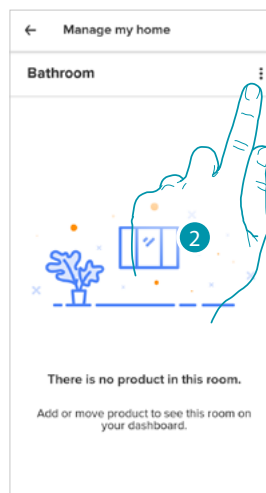
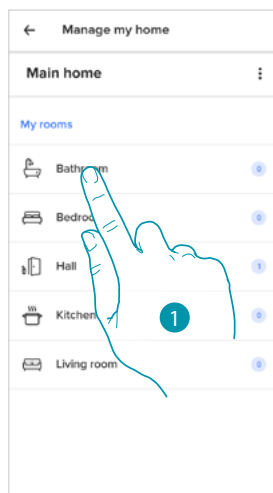

1. Touch to access the room
 2. Touch to open the room setting modification section
- A *Change the room name*
- B *[Delete the room](#)*

Delete the room

In this section, it is possible to delete a room.

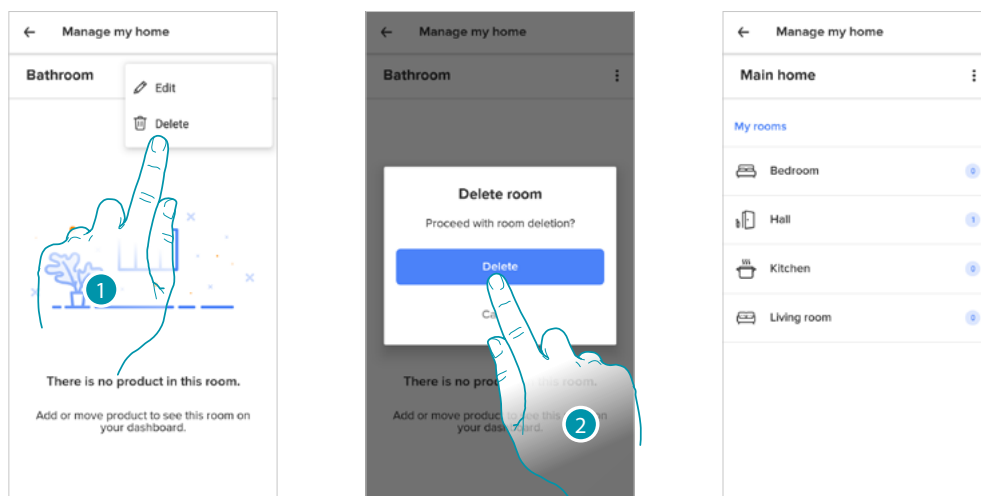

1. Touch to delete the room
2. Touch to confirm

Note: in order to remove a room, it will first be necessary to remove all the products installed inside the same.

Smarter settings

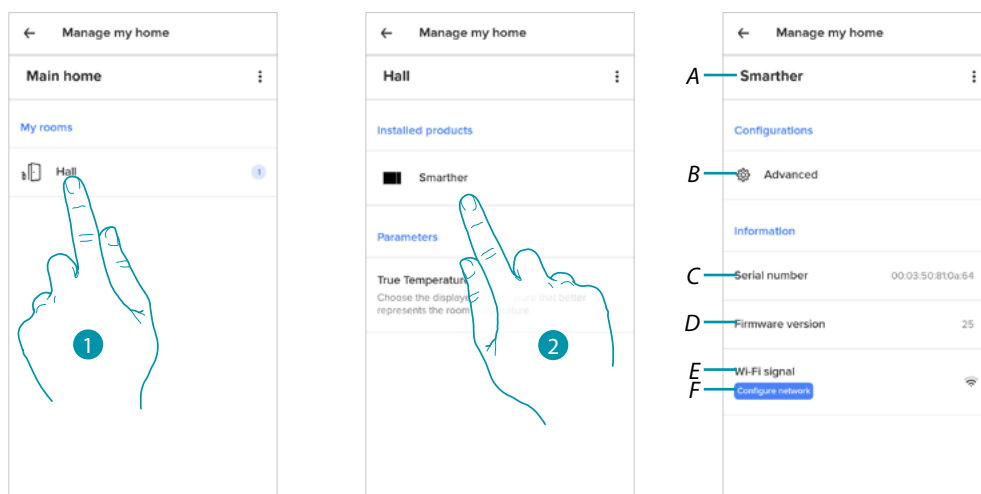

1. Touch to access the room where the Smarter has been inserted

2. Touch to access the device management page

A *Display the Smarter available options*

B *[Advanced](#)*

C *Display the device serial number*

D *Display the firmware version*

E *Display the Wi-Fi signal*

F *[Configure the Wi-Fi](#)*

Manage the Smarter

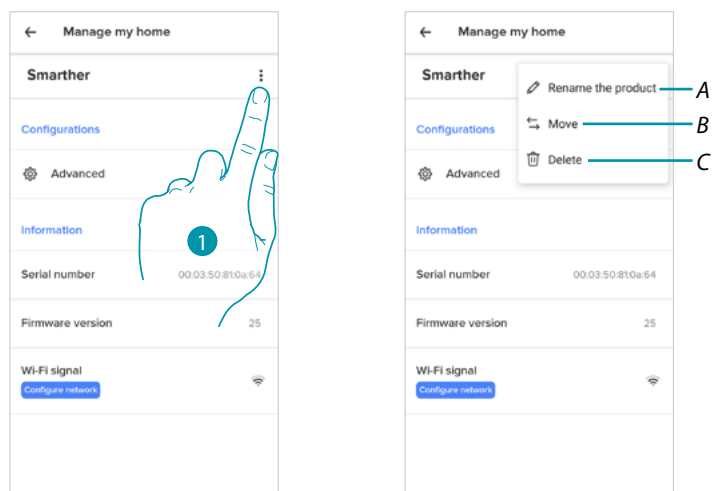

1. Touch to manage the device

A *[Rename the product](#)*

B *[Move](#)*

C *[Delete](#)*

Rename the product

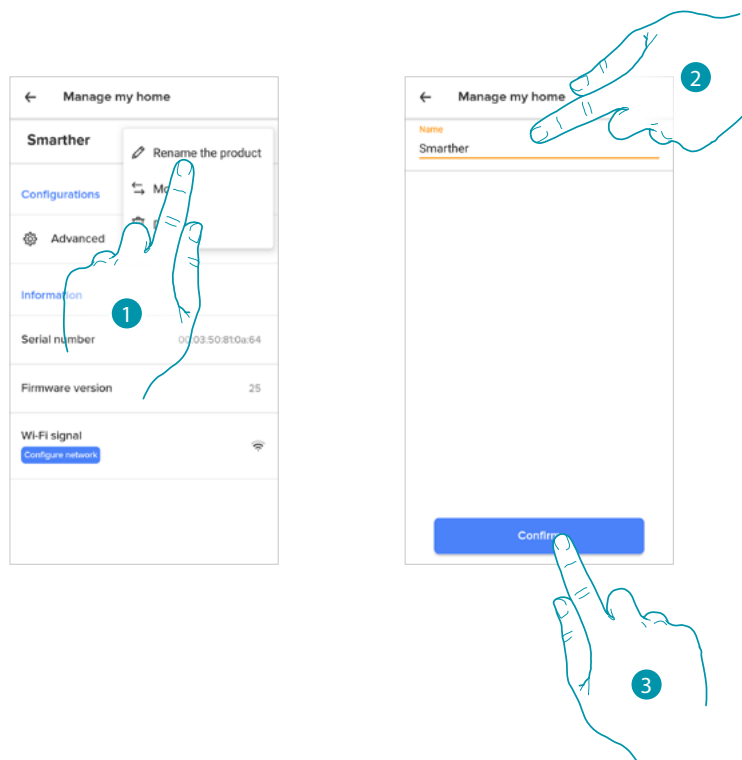

1. Touch to rename the Smarter
2. Rename the Smarter with an identification name
3. Touch to confirm

Move

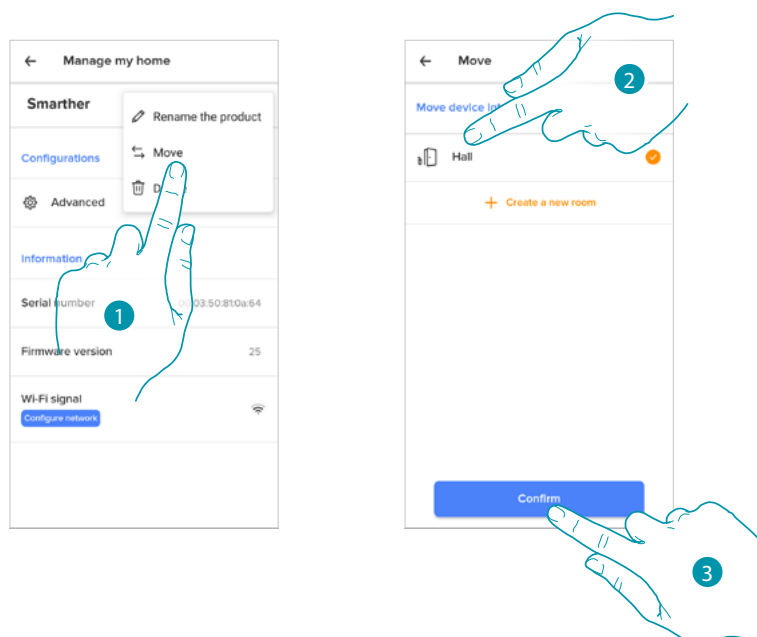

1. Touch to move the Smarter into another room
2. Touch to select the room where you want to insert the Smarter
3. Touch to confirm

Delete

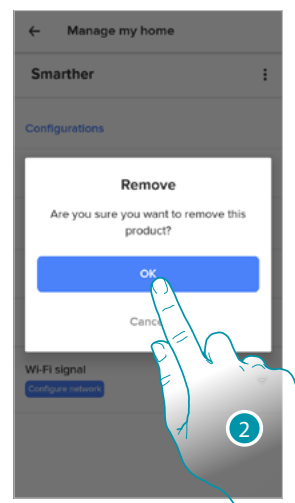
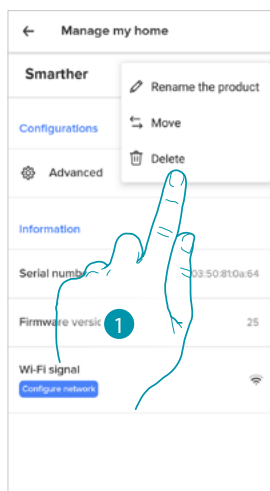

1. Touch to remove the Smarther from your home
2. Touch to confirm

Advanced

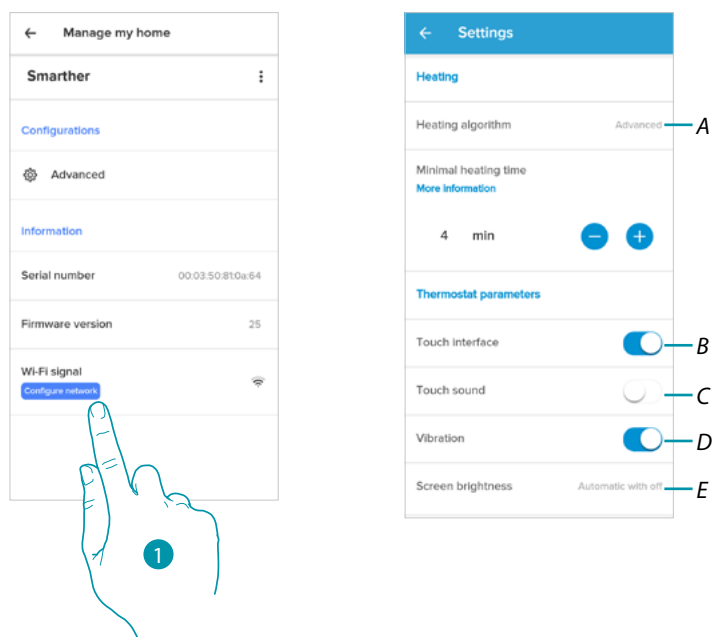

1. Touch to enter the advanced parameters section
- A Touch to select the [heating algorithm](#)
 - B Enable/disable the Smarter touch interface and the actual physical keys. If the function is disabled, it will no longer be possible to interact with the Smarter physical interface but only to display the information.
This function can be useful if you don't want the settings to be modified from the Smarter, but only from the App (e.g. children's bedroom or public establishment).
 - C Enable/disable the sound when touching the keys (both the screen keys and the physical keys).
 - D Enable/disable the vibration when touching the keys (both the screen keys and the physical keys).
 - E [Adjust the lighting level when the display is in stand-by](#)

Advanced heating algorithm

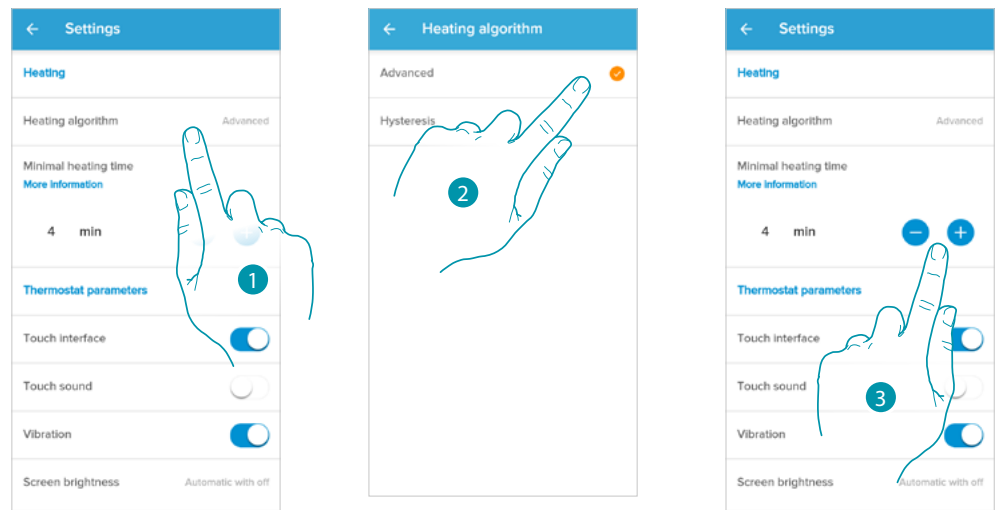

1. Touch to select the algorithm to use based on the type of system:
2. Touch to select the advanced algorithm: the thermostat manages the temperature in advanced mode controlling the opening of the valves, using some parameters which depend on the type of system installed; comfort can thus be optimised and consumptions rationalised in the best way.
3. Select the minimum time during which the thermostat will activate the system. This function is useful to avoid pointless system activations. For example, if the controlled thermostat valve has an opening time of 2 minutes, it is recommended that this parameter is set to 2 minutes.

Note: the menu setting for the selection of the advanced algorithm only appears a period of time after the thermostat has been installed in the operating system. This allows the thermostat to calculate the necessary parameters. The system will normally need at least 15 days before completing these calculations.

Heating algorithm Hysteresis threshold

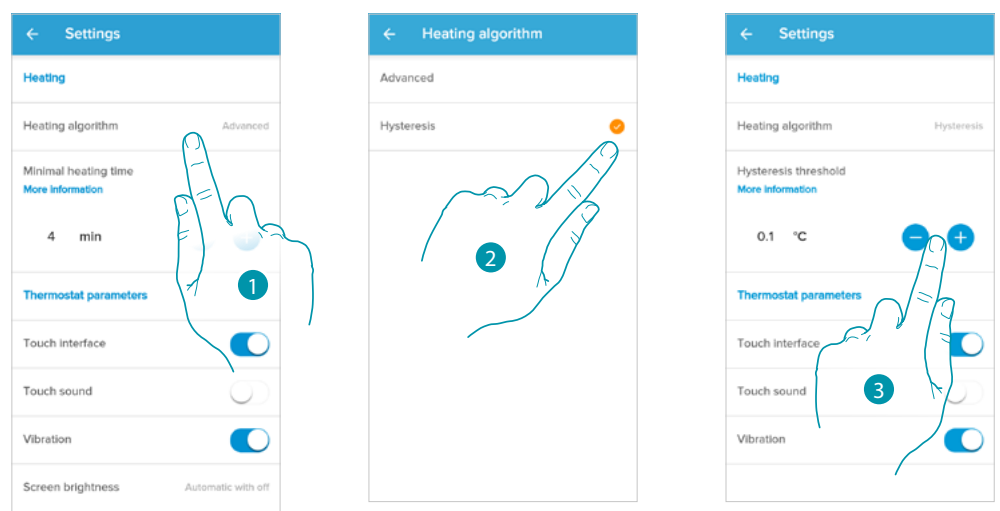

1. Touch to select the algorithm to use based on the type of system:
2. Touch to select the hysteresis algorithm: the capacity of a structure to change its temperature more or less slowly depending on the type of system and then according to the speed that the installed devices use to heat/cool.
3. Select the hysteresis value:
0,1°C: factory setting suitable for high hysteresis (slow) heating and cooling systems.
1°C: setting suitable for low hysteresis (fast) heating and cooling systems.

Display brightness

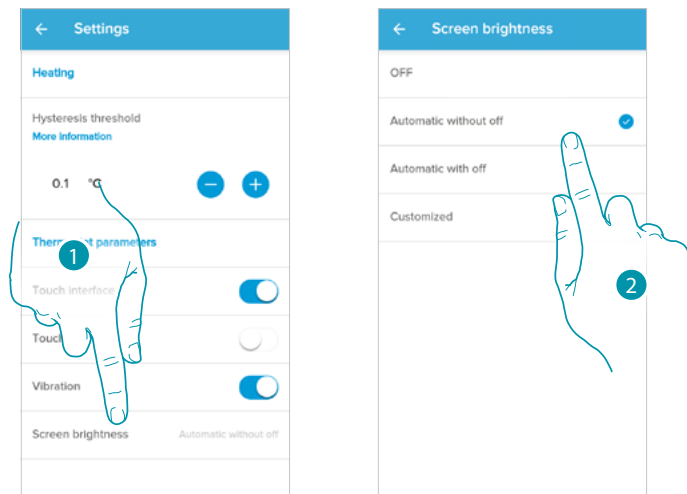

1. Touch to select the display lighting operating logic

After 10 seconds, the display switches off, goes to stand-by mode and performs the selected operating logic.

2. Select the mode among

OFF	It switches off
Automatic without off	Depending on the room brightness, it adjusts the display and, in case of low brightness, adjusts it to minimum
Automatic with off	Depending on the room brightness, it adjusts the display and, in case of low brightness, turns it off (e.g. night)
Customized	It adjusts the display in a precise and user-configurable way (see below)

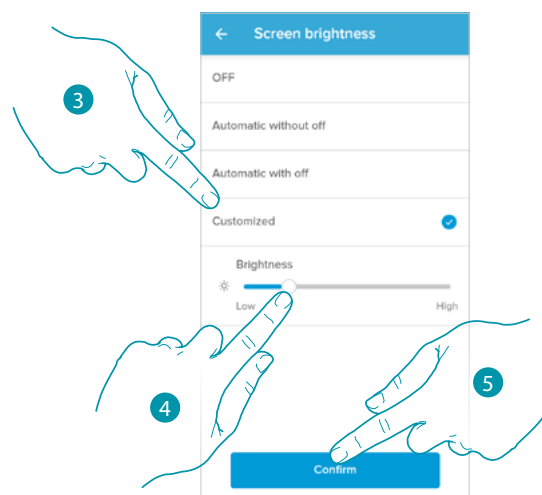

3. Select the customised mode

4. Scroll to adjust the brightness in stand-by precisely

5. Touch to save

Configure the network

In this section it is possible to set to which Wi-Fi network the Smarter is connected. This function is useful for example when replacing the router, or when you want to connect the Smarter to a network other than the one selected during the first installation.

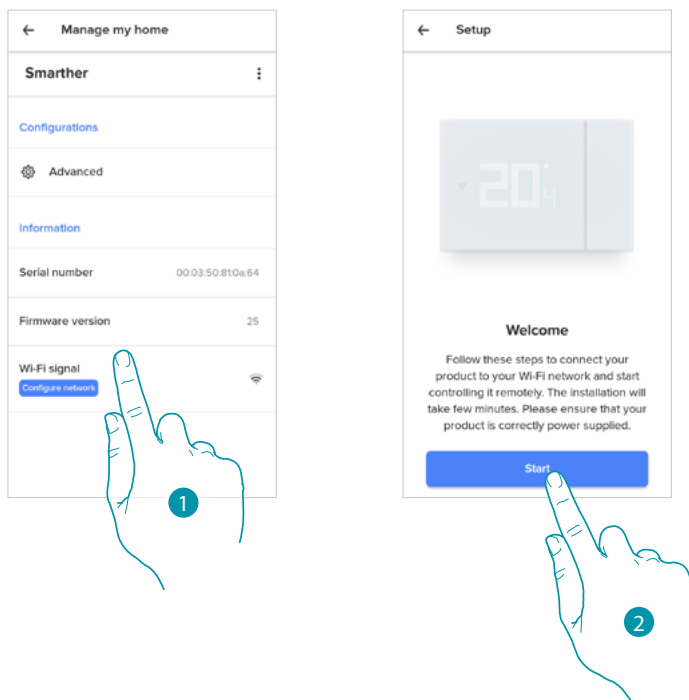

1. Touch to change the Wi-Fi network to which the Smarter is connected
2. Touch to start

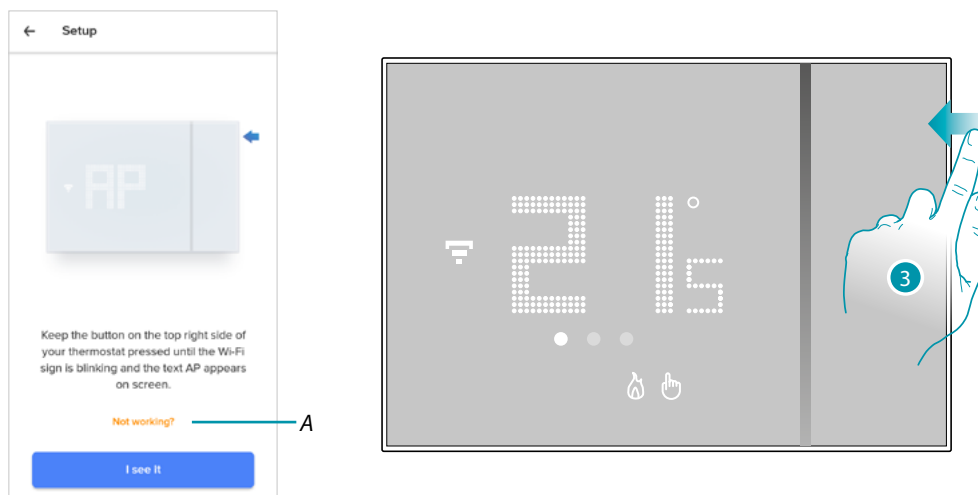

A Opens the FAQ to help in the resolution of the problem

3. Keep the upper Smarter pushbutton pressed until "AP" appears

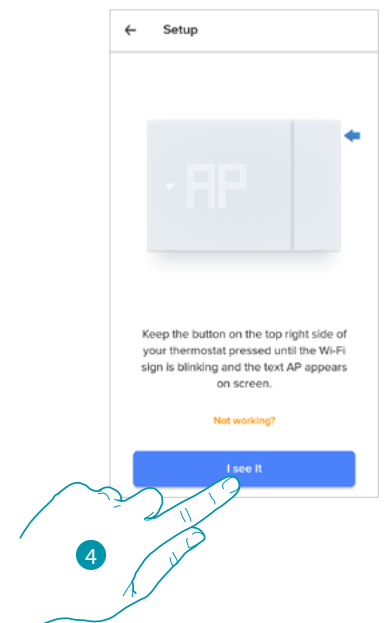

4. Press to continue

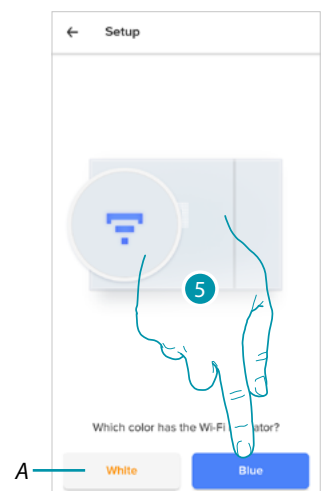

5. The Smarter shows the blue Wi-Fi symbol. Touch it to continue the configuration

A Indicates that you are trying to complete the association using an incorrect App

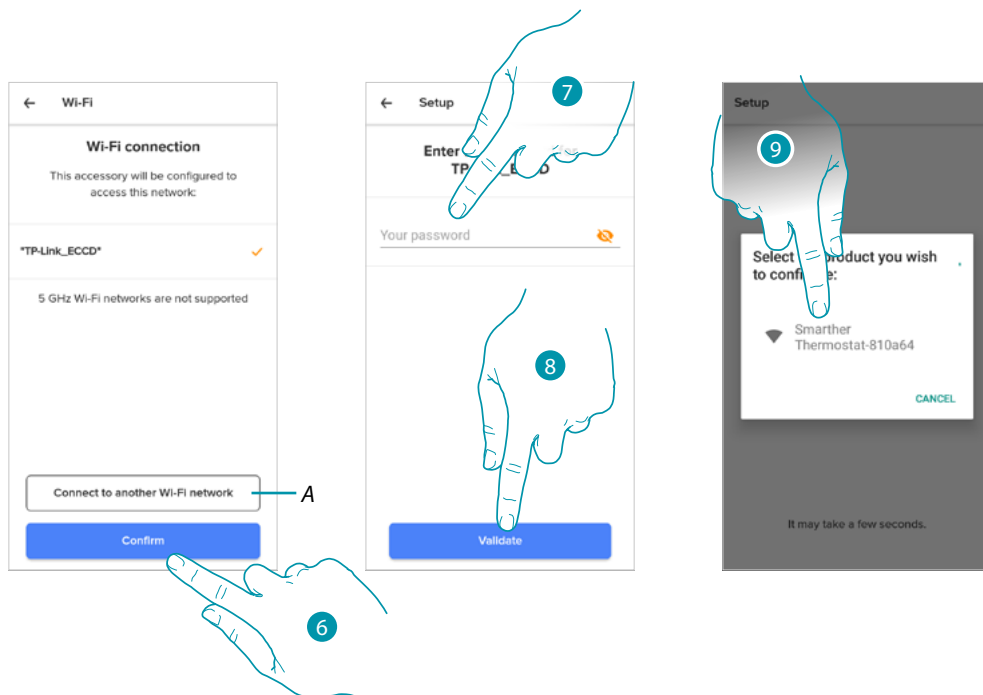

6. Touch to confirm the suggested home Wi-Fi network, otherwise touch (A) to select a different one
7. Enter the home Wi-Fi password
8. Touch to continue
9. Select the Smarter

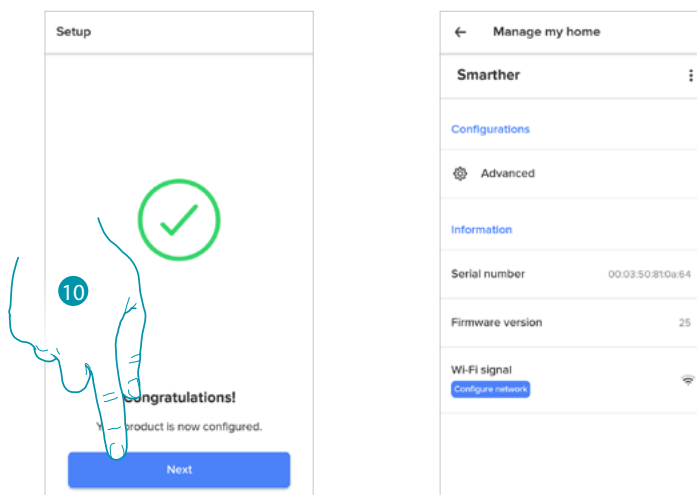

10. The Smarter is configured correctly; touch to end the procedure

Valve settings

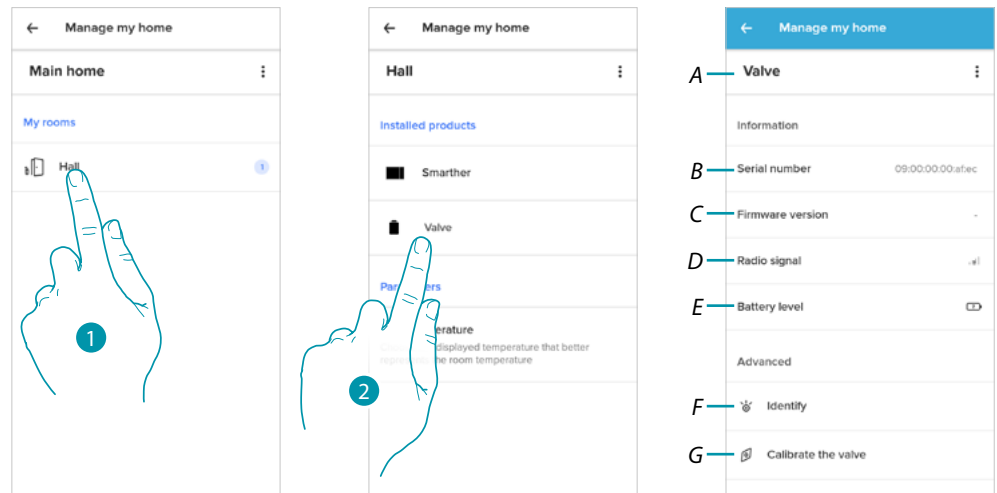

1. Touch to access the room where the Netatmo thermostat valve has been inserted

2. Touch to access the device management page

A Display the Netatmo thermostat valve available options

B Display the device serial number

C Display the firmware version

D Display the radio signal

E Display the battery level

F When pressed, the valve shows an identification number

G When pressed, the valve calibration procedure starts

A sound from the Valve (motor element movement) indicates that the calibration is being performed.

Manage Valves

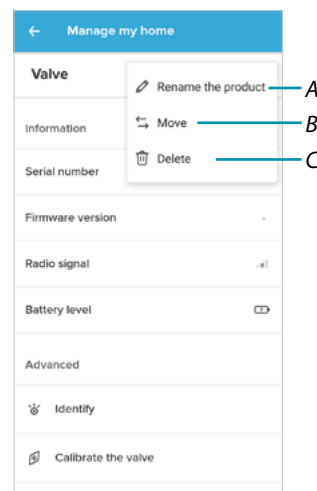
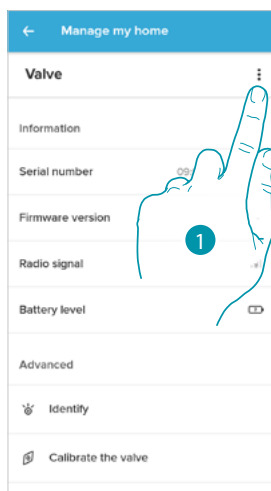

1. Touch to manage the device

A [Rename the product](#)

B [Move](#)

C [Delete](#)

Rename the product

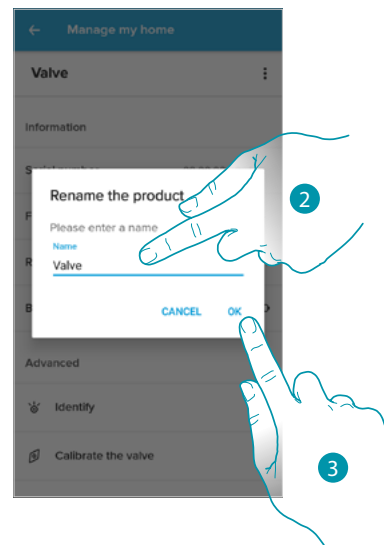
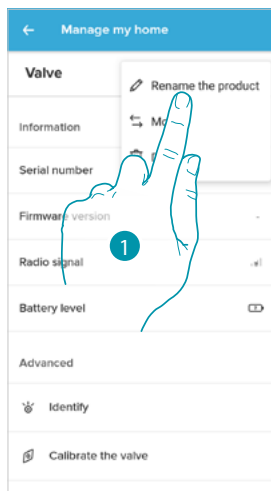

1. Touch to rename the Netatmo thermostat valve

2. Rename the Netatmo thermostat valve with an identification name

3. Touch to confirm

Move

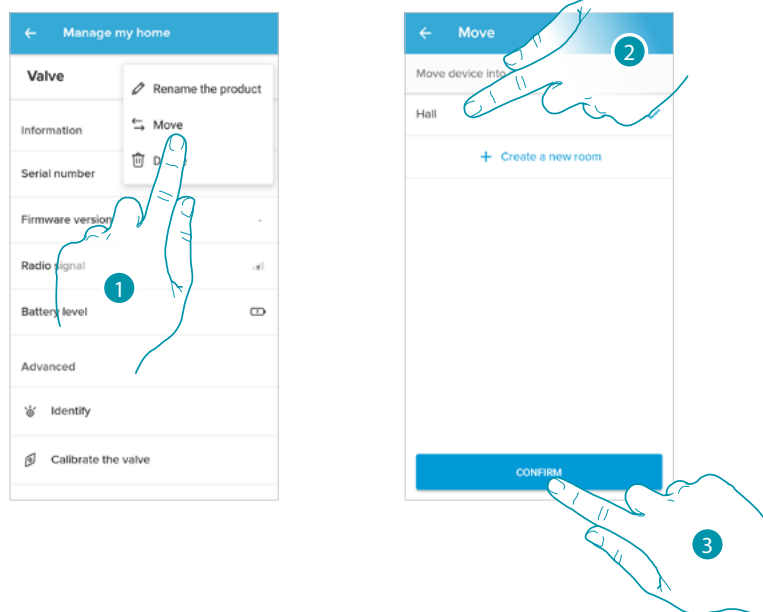

1. Touch to move the Netatmo thermostat valve into another room
2. Touch to select the room where you want to insert the Netatmo thermostat valve
3. Touch to confirm

Delete

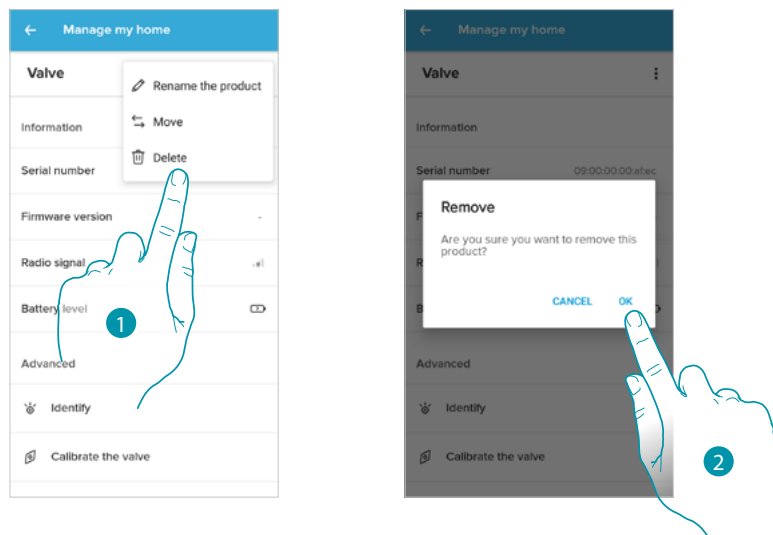

1. Touch to remove the Netatmo thermostat valve from your home
2. Touch to confirm

Parameters

Real time

Depending on the position of the thermostat or the valve, it is possible to note differences between the temperature displayed on the thermostat and the temperature displayed, for example, on a thermometer; this function can be used to select the temperature displayed on the thermostat that best represents the room temperature.

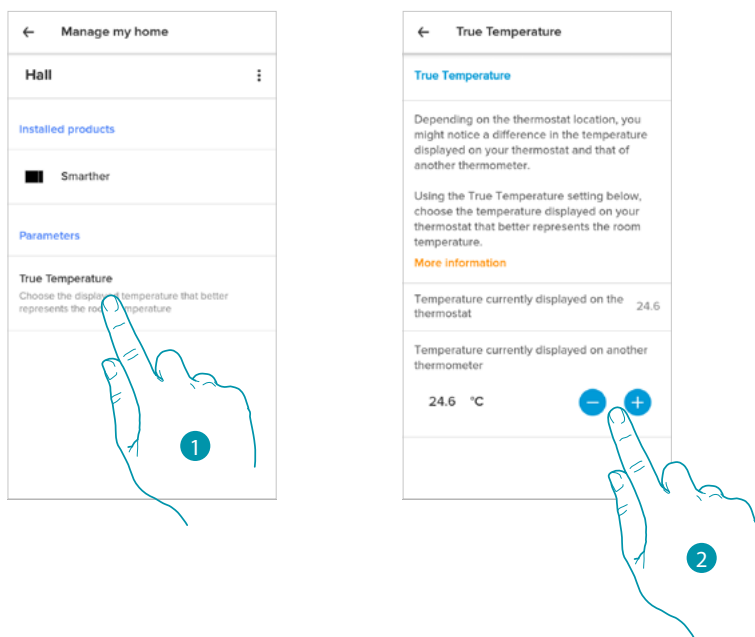



1. Touch to access the section of the real temperature as measured by the Smarter
2. Select the real temperature measured

Schedules

During the association of your Smarter with your Smartphone, through the answers to some questions regarding your living habits the tutorial has allowed you to create a program that manages the temperature inside the home based on your needs.

The created program sets different temperatures based on time and week day; available preset temperatures are:

ECO  Temperature to set when you are not at home

COMFORT  Temperature to set when you are at home

COMFORT +1  Temperature to set when you are cold

NOTTE  Temperature to set at night

It is possible to change the set points, or create new ones; see [Set point](#)

Create a new program

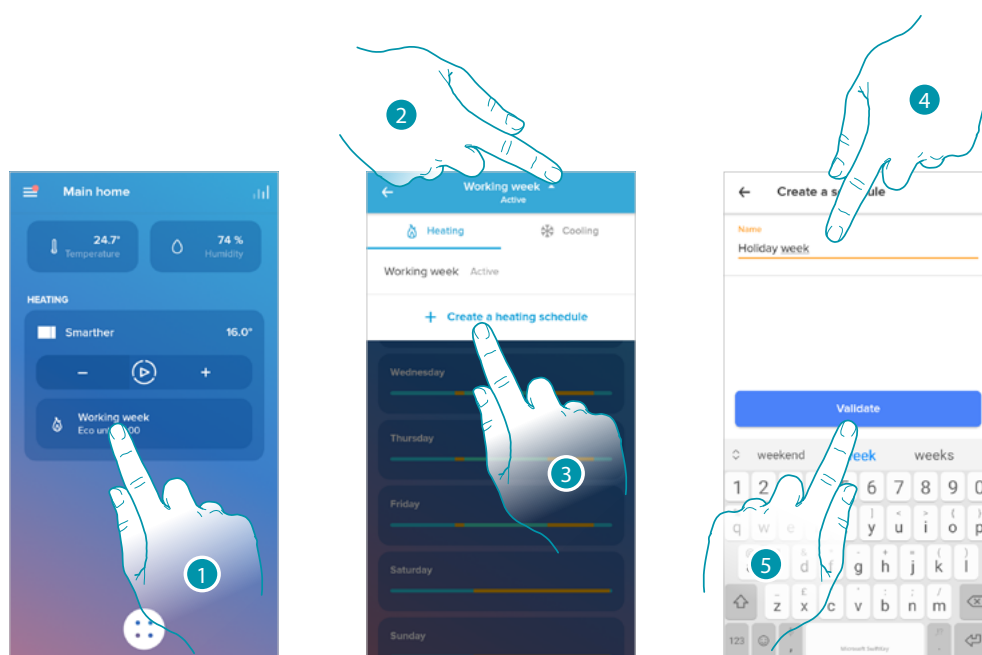

1. Touch to access the Programs section
2. Touch to open the Programs menu
3. Touch to create a new program
4. Enter a name for the program
5. Touch to confirm

Now create a new program using the [guided procedure](#).

Note: in addition to creating a new program through the guided procedure, it is also possible to customise an existing program (see "[Example of creation of a new program from an existing one](#)")

Duplicate a program

Via this function you can copy and if necessary modify an existing program

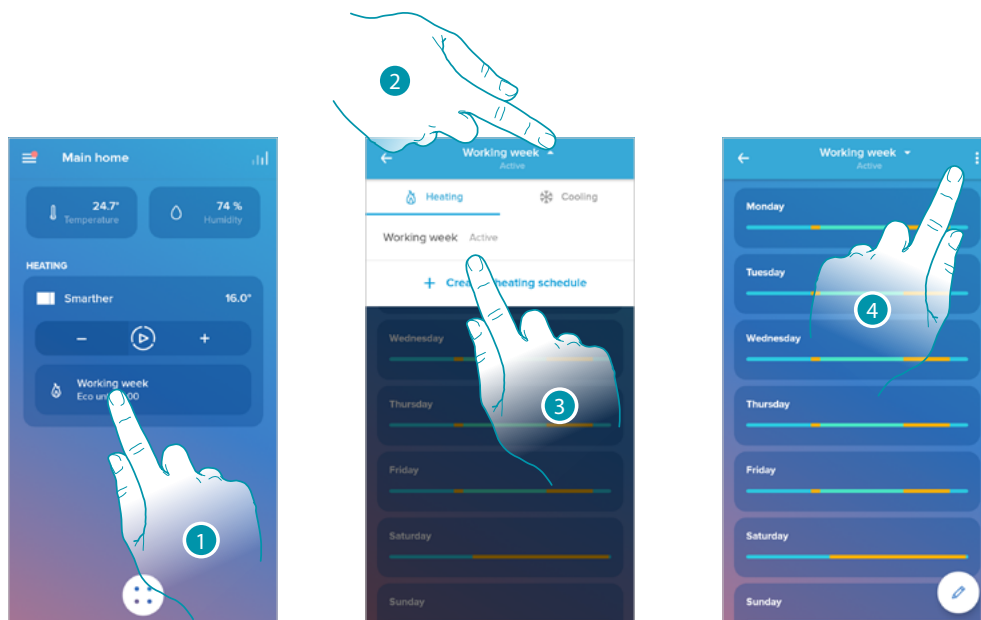

1. Touch to access the Programs section and create a new program* by duplication
2. Touch to select the program to copy
3. Select the program to copy
4. Touch to duplicate the program

***Caution:** each Smarter can manage up to 10 programs, 150 weekly temperature variations and 12 different temperatures

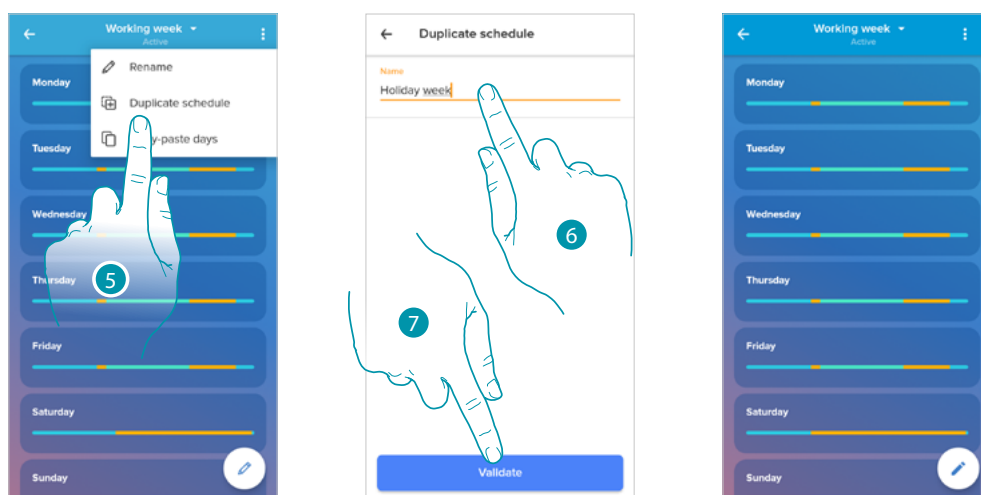

5. Select to duplicate the program
6. Enter a description for the program
7. Touch to confirm

Now the program appears in the program list and can be [activated](#), [modified](#) or [deleted](#).

Rename a program

This function allows to rename a program.

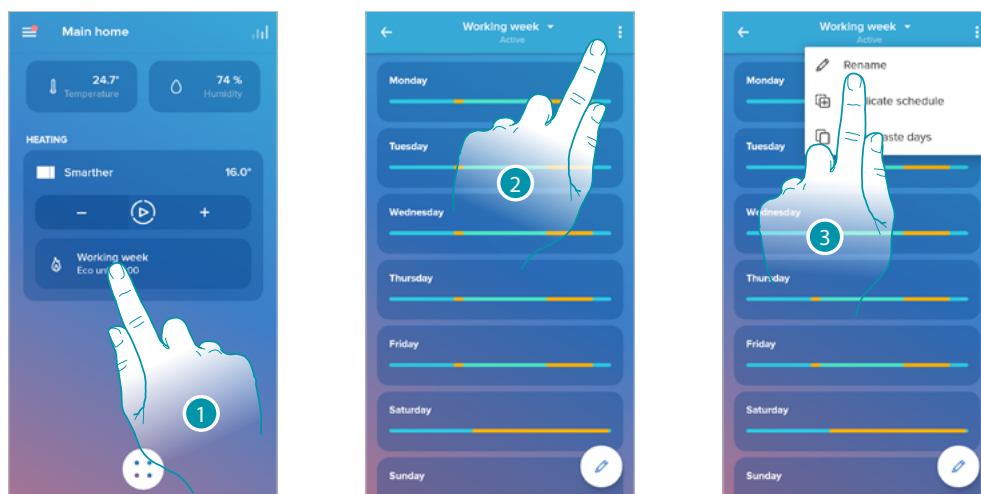

1. Touch to access the Programs section
2. Touch to display the program options
3. Touch to rename the program

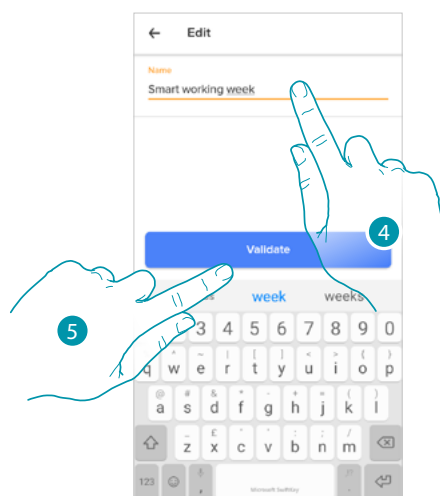

4. Rename the program
5. Touch to confirm

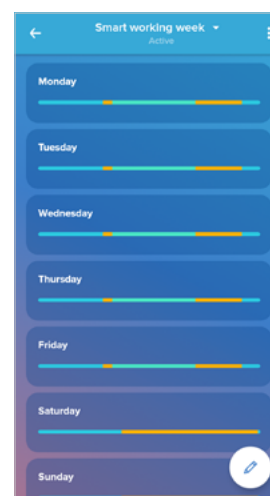

Change a time interval

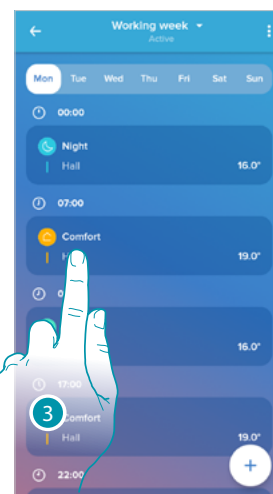
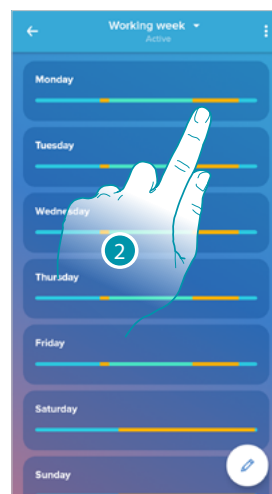
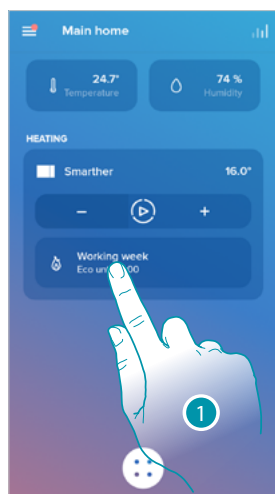

1. Touch to access the Programs section
2. Touch to select one of the available programs
3. Touch to select the time interval to modify

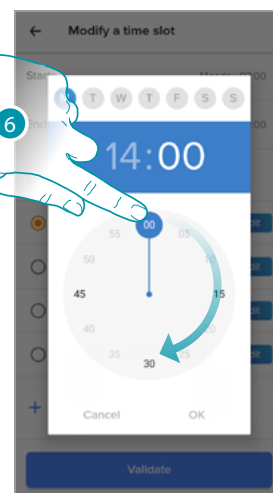
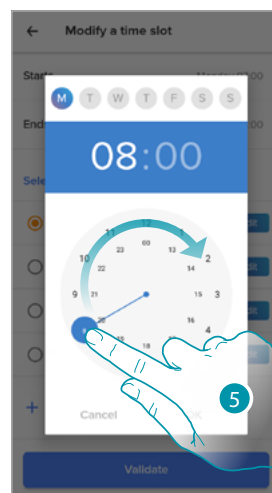
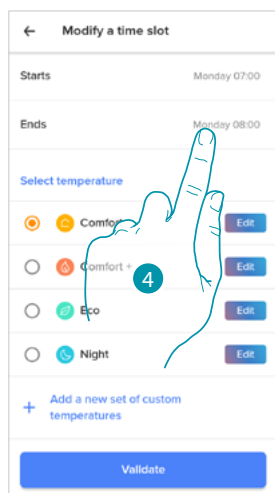

4. Touch to select the interval end date and time
5. Select the interval end hour
6. Select the interval end minutes

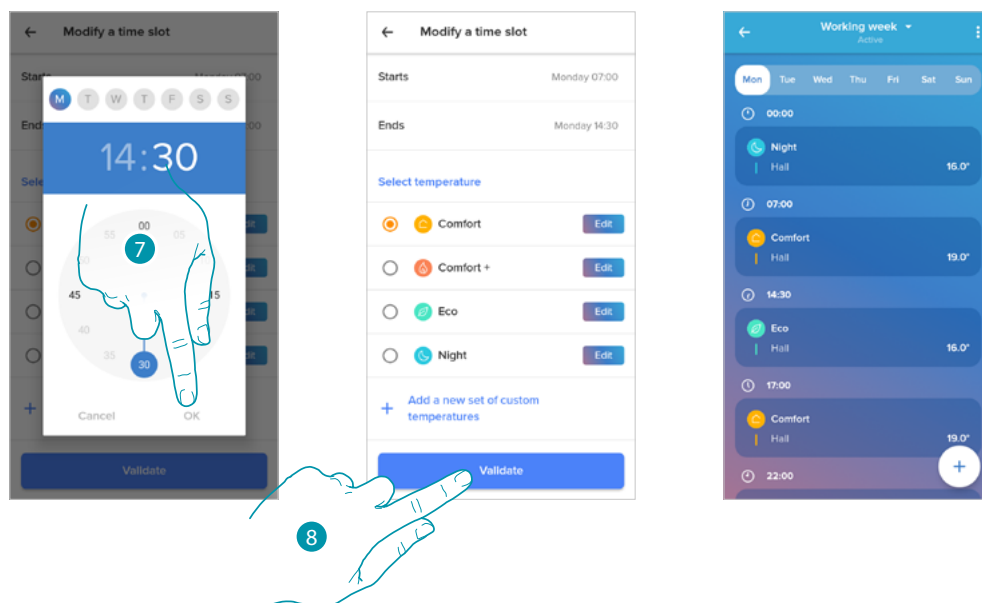

7. Touch to confirm the selected hours and minutes
8. Touch to confirm the modification

Activate a program

After creating the programs you must activate the one you want

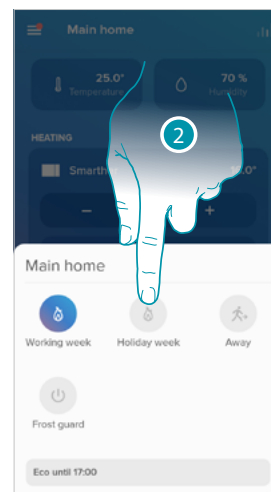
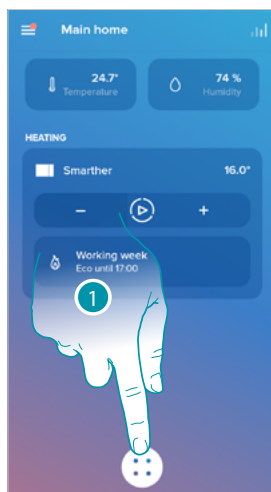

1. Touch to open the Schedules menu
2. Select the program to activate

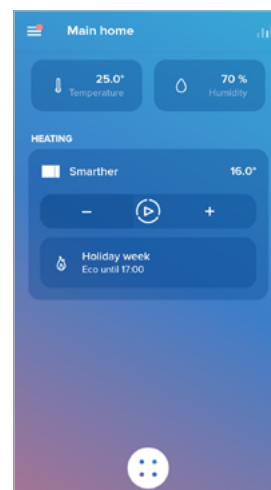
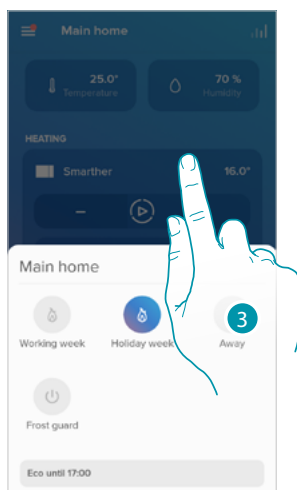

3. Touch to close the Schedules menu
- The program is now active

Delete a program

This function gives the possibility of definitively removing an existing program.

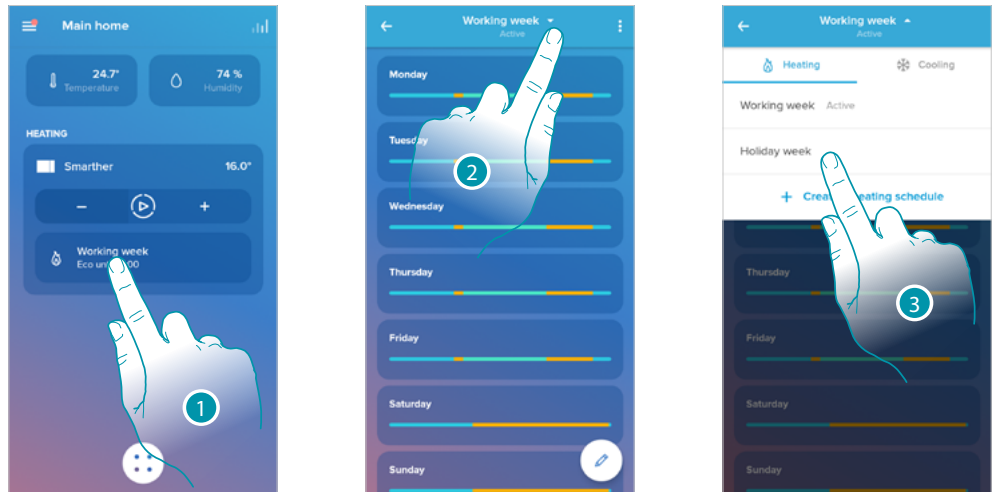

1. Touch to access the Programs section
2. Touch to select on of the available programs
3. Select the program to delete

Note: active programs cannot be deleted.



4. Touch to delete the program
5. Delete the program
6. Touch to confirm the program deletion

Copy-paste the days

This function gives the possibility of copying the profile created for a certain day to one or more days of the week.

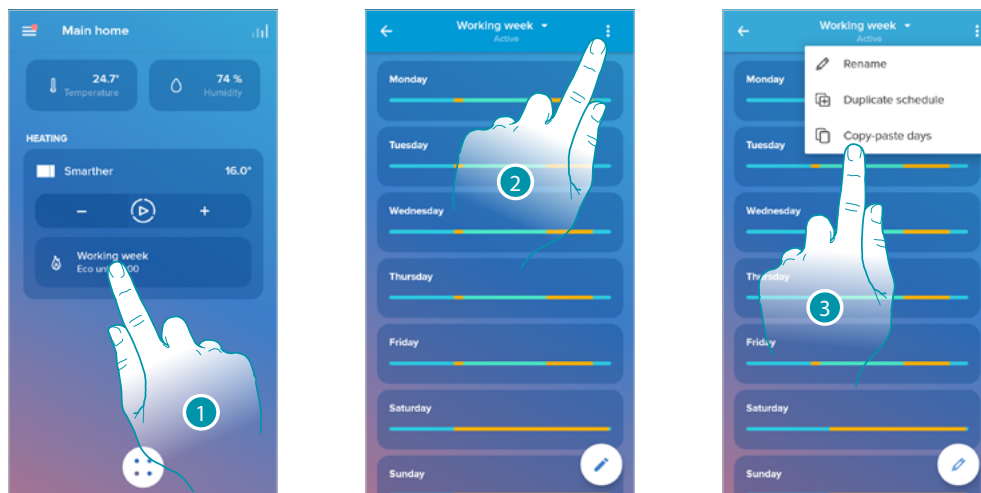

1. Touch to enter the Programs section
2. Touch to display the available functions for the program
3. Touch to select the function that will allow you to copy-paste the days

In this example, the Friday profile is also repeated on Saturday and Sunday

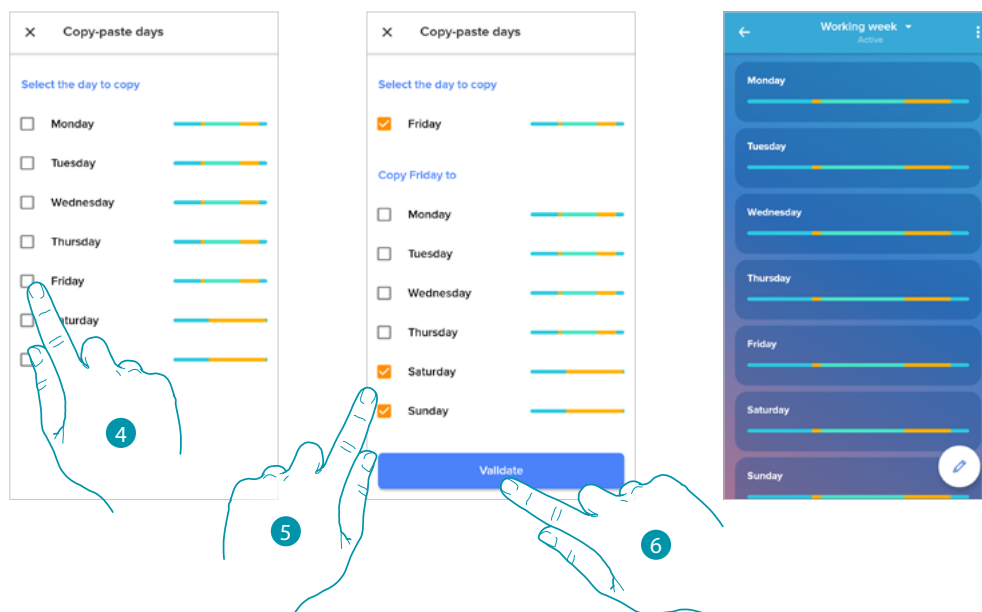

4. Select the day with the profile to copy
5. Select the day or the days on which you want to repeat the profile
6. Touch to confirm

Set point

It is possible to add or delete custom set points, for a better management of the programs on your Smarter, in addition to changing the default set point temperature.

Add a set point

This function gives the possibility of adding set points, customising the temperature and name based on personal needs. The set point is only added to the current program.

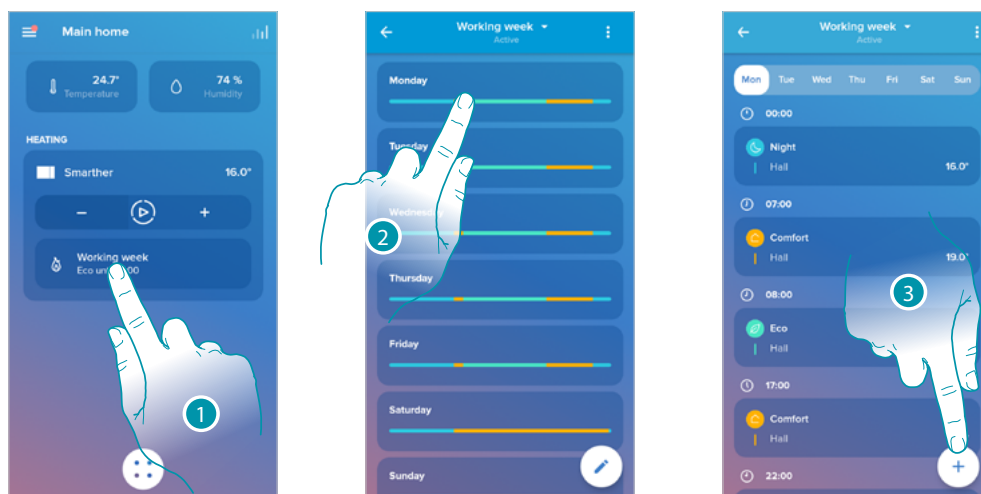

1. Touch to enter the Programs section
2. Enter the day in which you want to insert the custom set point
3. Touch to enter the customised set point

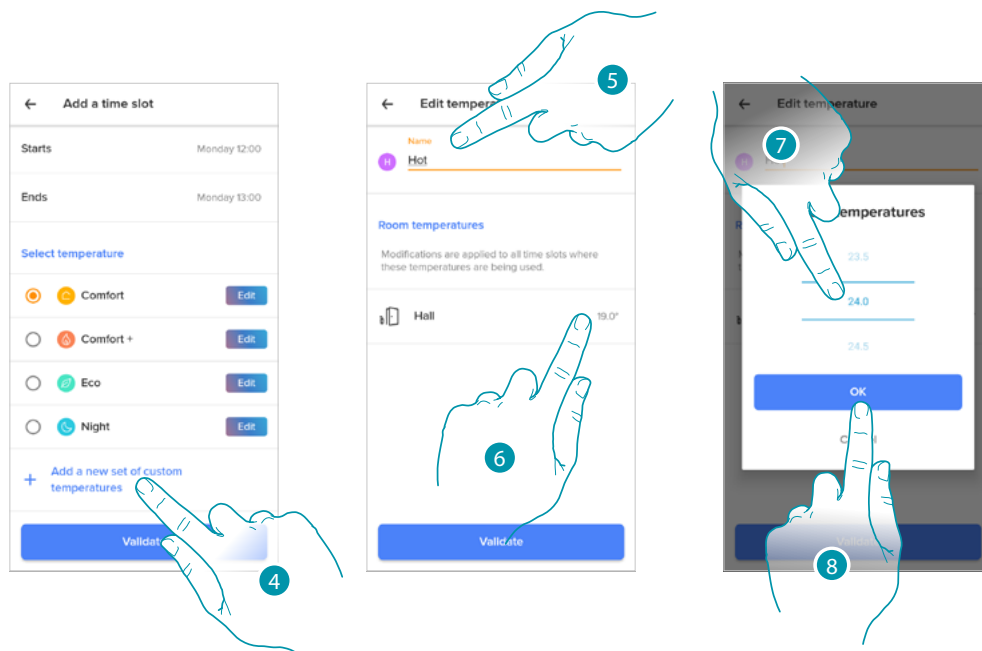

4. Touch to add a set point
5. Customise the name
6. Touch to select the set point temperature
7. Scroll to select the temperature
8. Touch to confirm

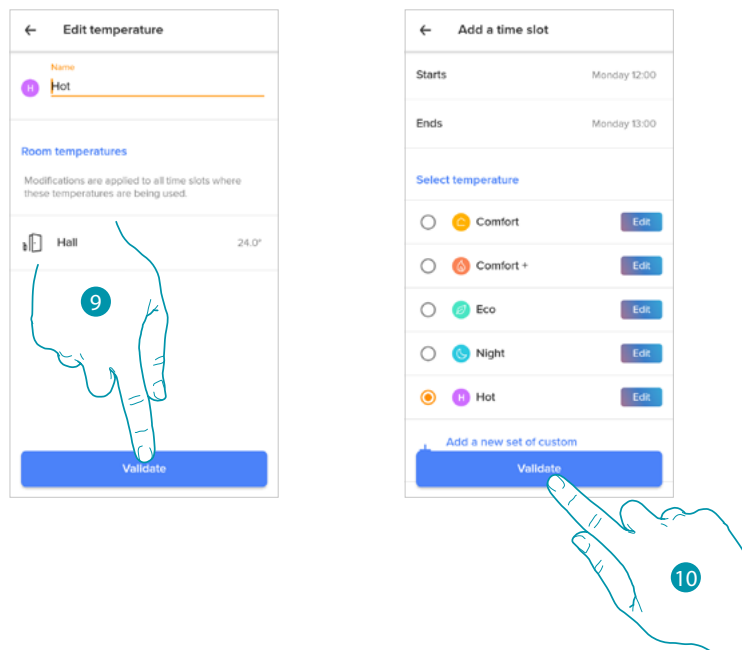

9. Touch to create the customised set point

10. Touch to confirm

Change a set point

This function allows to change the temperature of an existing set point.

E.g. 2°C increase of the comfort set point, which therefore goes from 19°C to 21°C

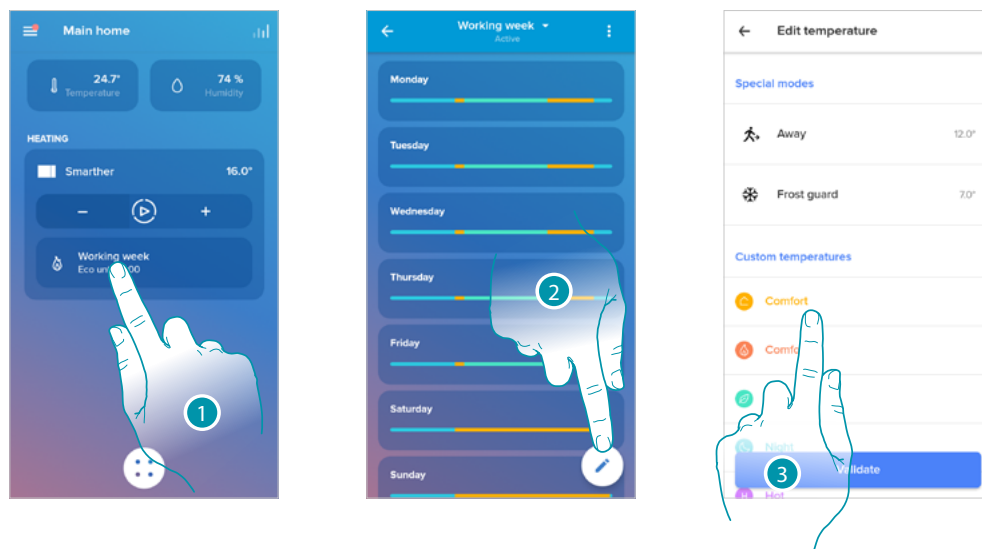

1. Touch to enter the Programs section

2. Touch to change the set point temperature

3. Select the set point for which you want to change the temperature

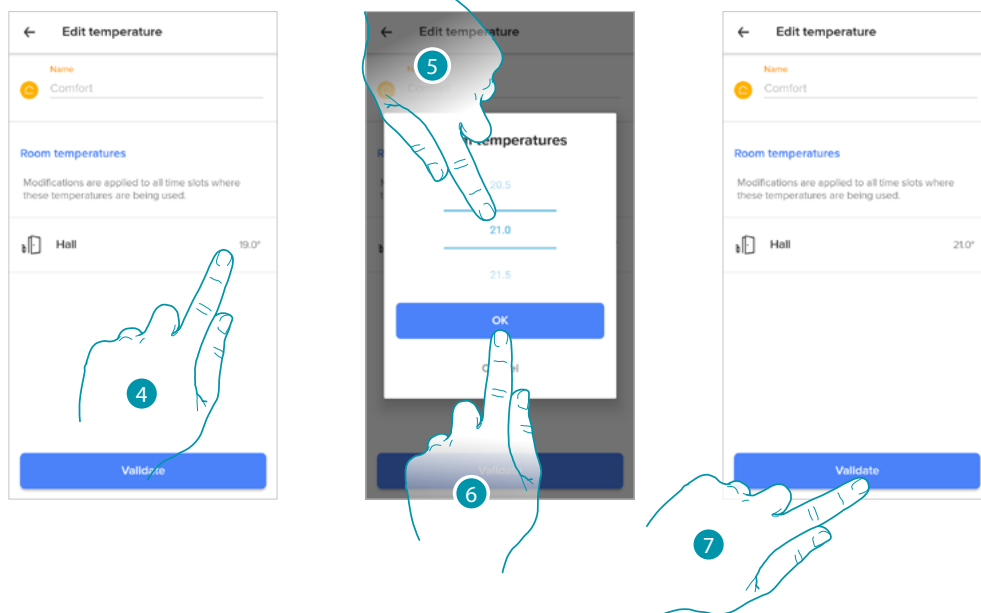

4. Touch to select the set point temperature
5. Scroll to select the desired temperature
6. Touch to confirm
7. Touch to confirm the modified set point

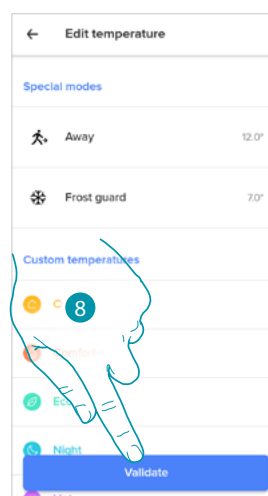

8. Touch to confirm the modification of the set point

Delete a set point

This function allows to delete the created set point.

Note: set points cannot be changed by default (Comfort / Comfort + / Eco / Night).

Note: only set points not appearing in a program can be deleted.

Set points appearing in a program can only be deleted after being deleted from the programs for the individual days.

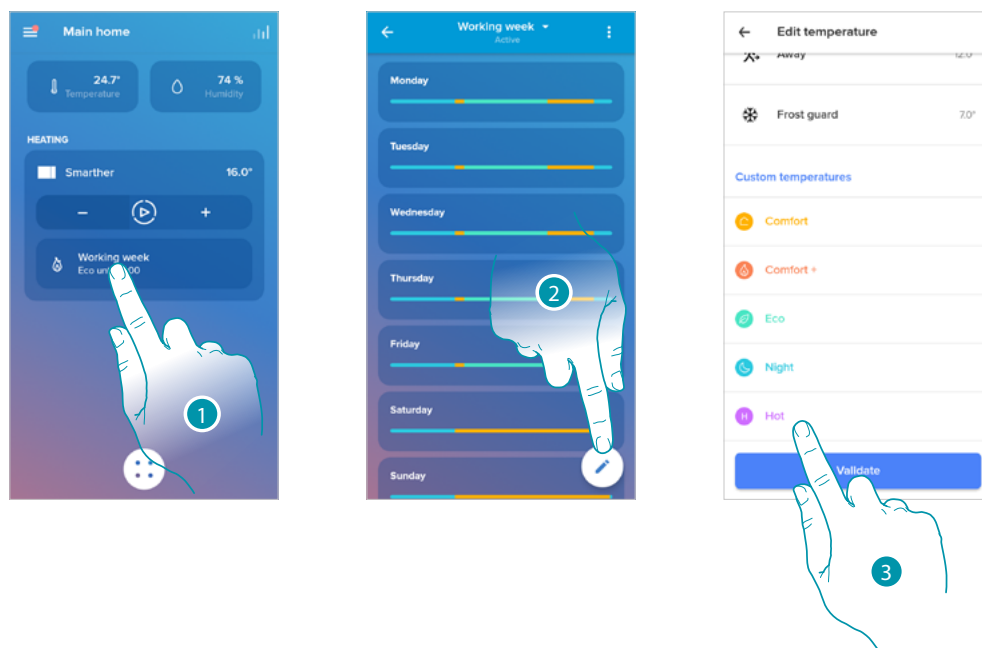

1. Touch to enter the Programs section
2. Touch to display all the available set points for the selected program
3. Select the set point to delete

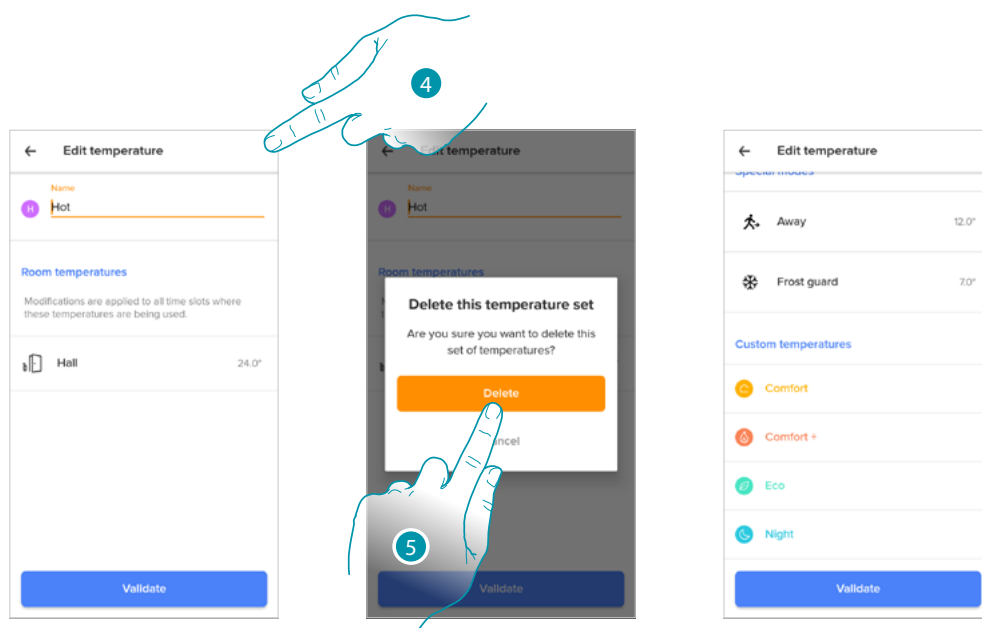

4. Touch to permanently delete the set point
5. Touch to confirm

Example of creation of a new program from an existing one

It is possible to change a program defining the various parameters which make up the program (temperature levels, time intervals and days of application) specifically and in a totally free way. Let's now see how we can change an existing program so that it includes the following settings:

- away from home for one week;
 - change the profile on Wednesday, the day when the maid will visit;
 - guarantee optimum temperature upon return.
1. from 00:00 on Sunday to 14:00 on Wednesday the temperature must be set to the "eco" setpoint (16°C)
 2. from 14:00 on Wednesday to 18:00 on Wednesday the temperature must be set to the "Comfort" setpoint (19°C)
 3. from 18:00 on Wednesday to 23:45 on Friday the temperature must be set to the "eco" setpoint (16°C)
 4. Saturday follows the same temperature of the existing program

Note: Smarter updates its own internal time once a day using the server NTP.

This procedure requires that at the moment of the request Smarter is powered and that the Internet connection is working.

In case of lack of power supply, the internal Smarter own time is preserved for one day using the internal battery. After this, and as soon as available Smarter will recover the clock data from the NTP server.

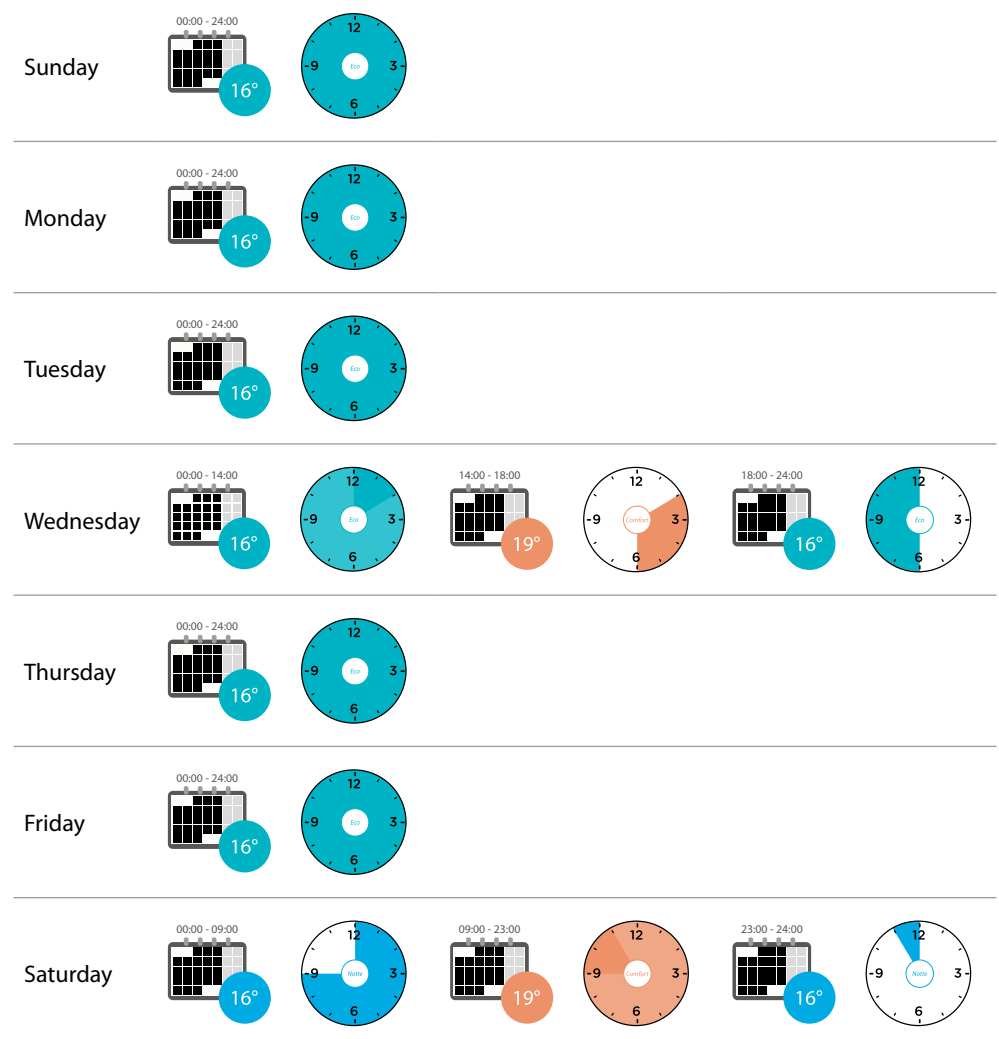

In order to create a new program meeting the previously described conditions, copy the existing program and then customise it:

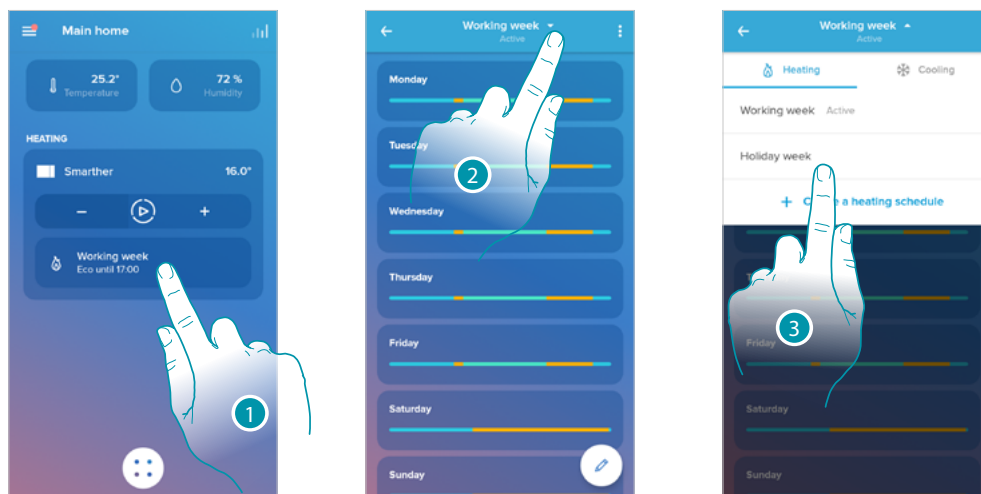

1. Touch to access the Programs section
2. Touch to select the program to change
3. Select the program to change

1. From 00:00 on Sunday to 14:00 on Wednesday set the temperature to the "Eco" setpoint (16°C)

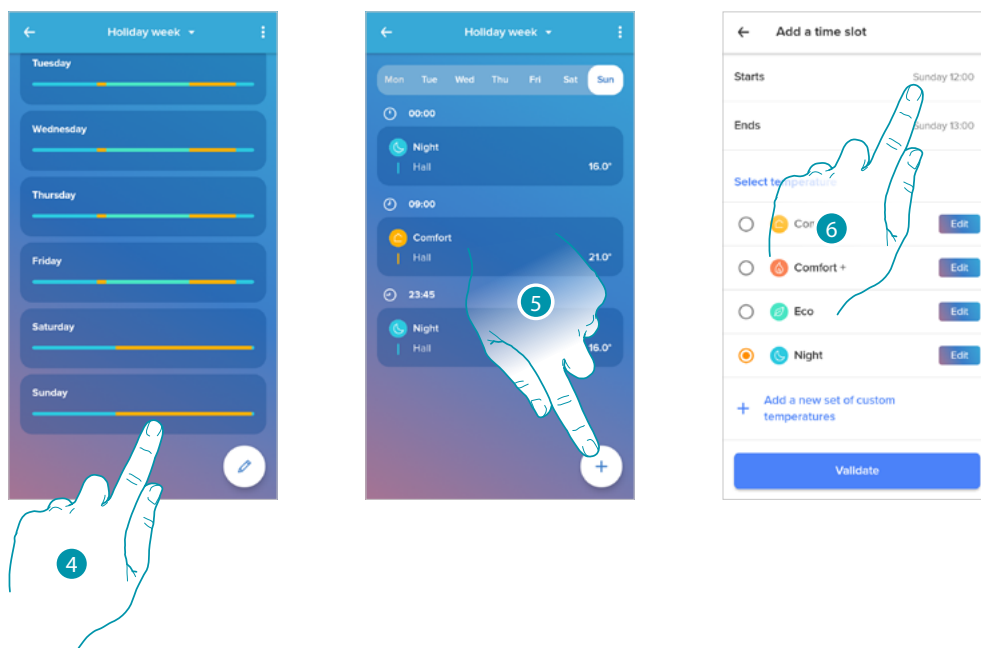

4. Touch the day of the week
5. Touch **+** to enter the start and end times for the first interval*
6. Touch to select the interval start time

**Note: it is possible to enter up to 8 intervals in a single program*

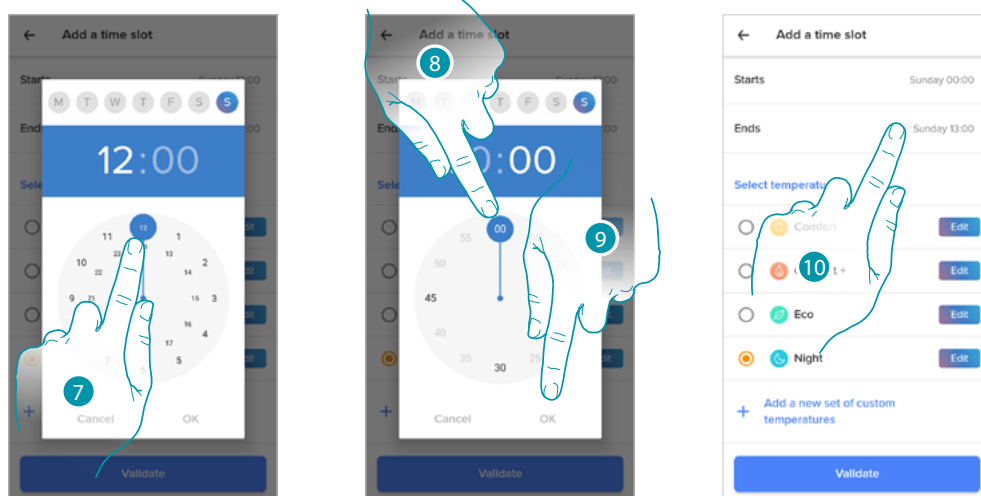

7. Select the interval start hour
8. Select the interval start minutes
9. Touch to confirm
10. Touch to select the interval end date and time



11. Select the interval end day
12. Select the interval end hour and minutes and confirm
13. Select the temperature set point to use for the days and times just created

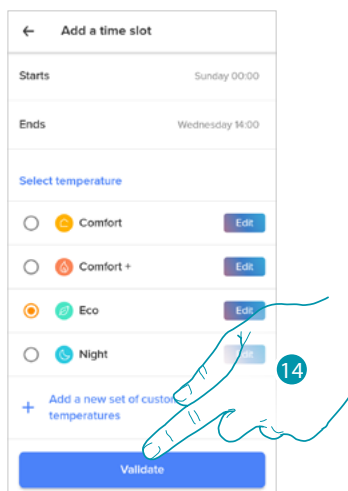

14. Touch to confirm

2. From 14:00 on Wednesday to 18:00 on Wednesday set the temperature to the "Comfort" setpoint (19°C)

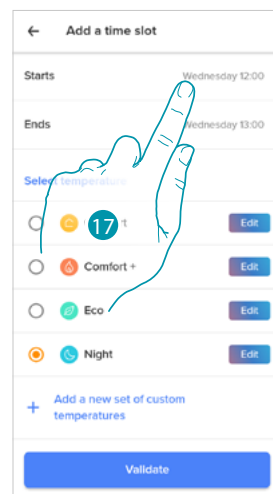
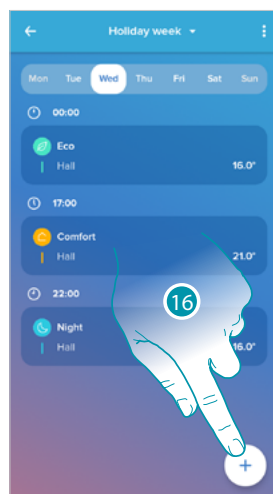
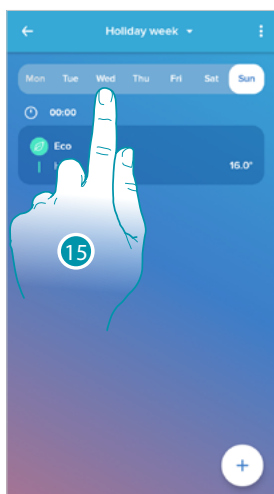

15. Select the day of the week when the maid will visit

16. Touch (+) to enter the start and end times for the second interval

17. Touch to select the interval start time

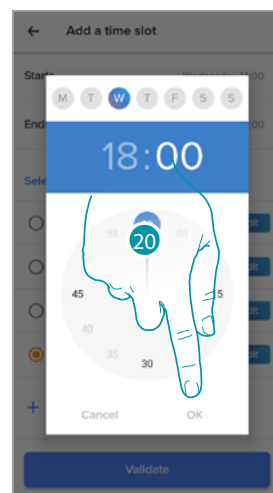
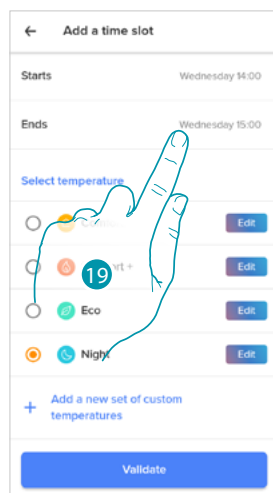
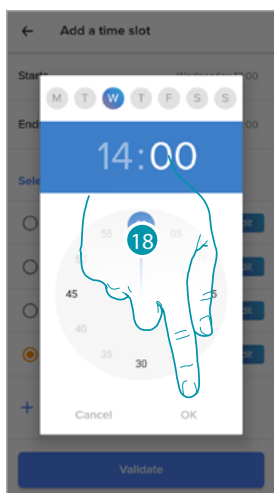

18. Select the interval start hour and minutes and confirm

19. Touch to select the interval end time

20. Select the interval end hour and minutes and confirm

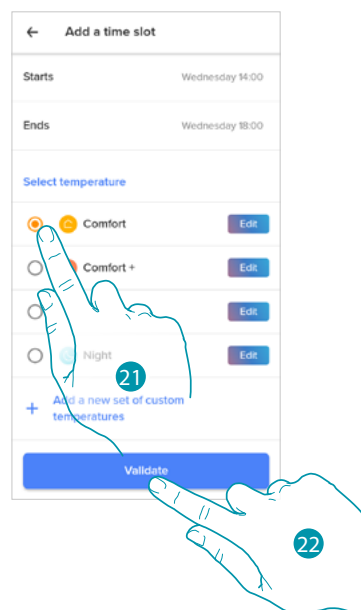

21. Select the temperature set point to use for the days and times just created

22. Touch to confirm

3. From 18:00 on Wednesday to 23:45 on Friday set the temperature to the "ECO" setpoint (16°C)

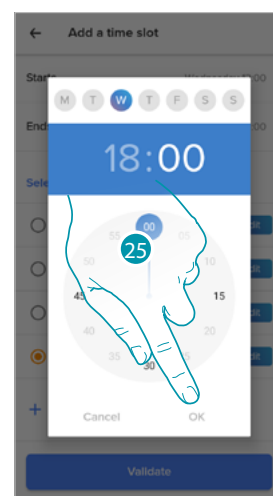
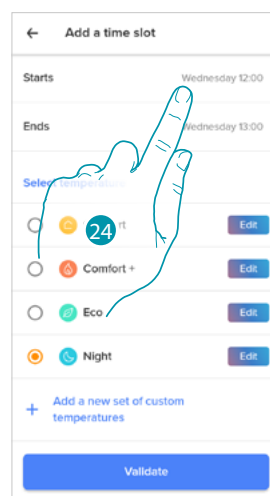
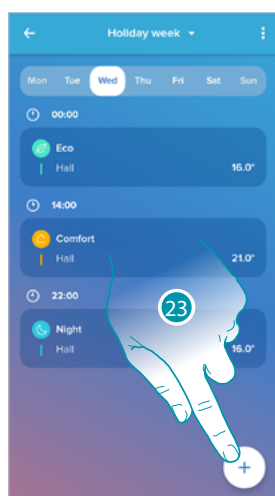

23. Touch **+** to enter the start and end times for the third interval

24. Touch to select the interval start time

25. Select the interval start hour and minutes and confirm

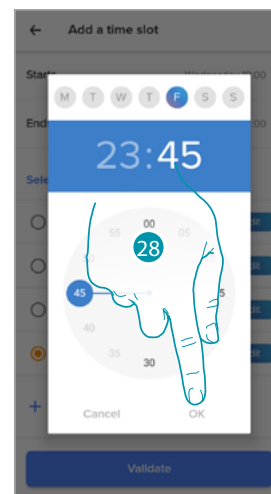
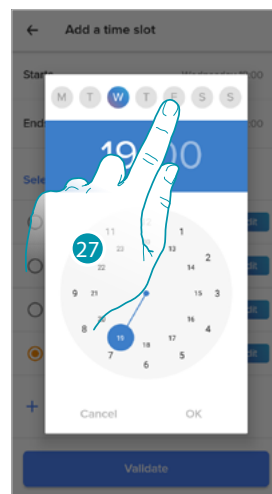
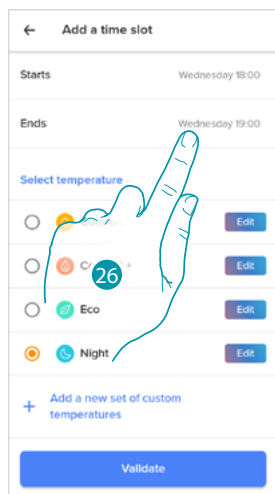

26. Touch to select the interval end date and time

27. Select the interval end day

28. Select the interval end hour and minutes and confirm

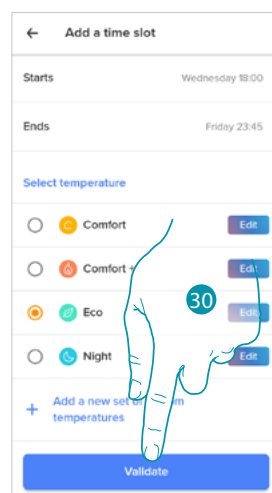
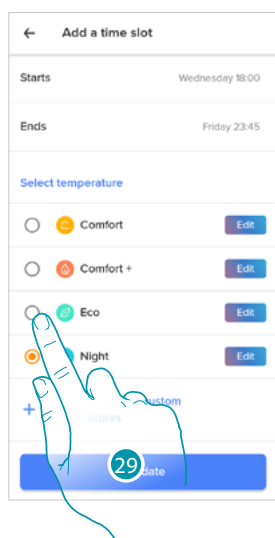

29. Select the temperature set point to use for the days and times just created

30. Touch to confirm

31. Touch to display the created week

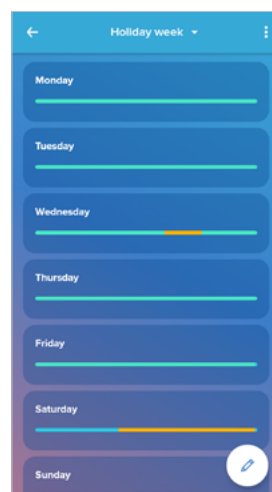

Thermal comfort

In this section it is possible to set the default time during which the manual temperature setting function will remain active. It is also possible to activate the self-adaptive forecast of the time required for reaching a certain temperature at a certain time.

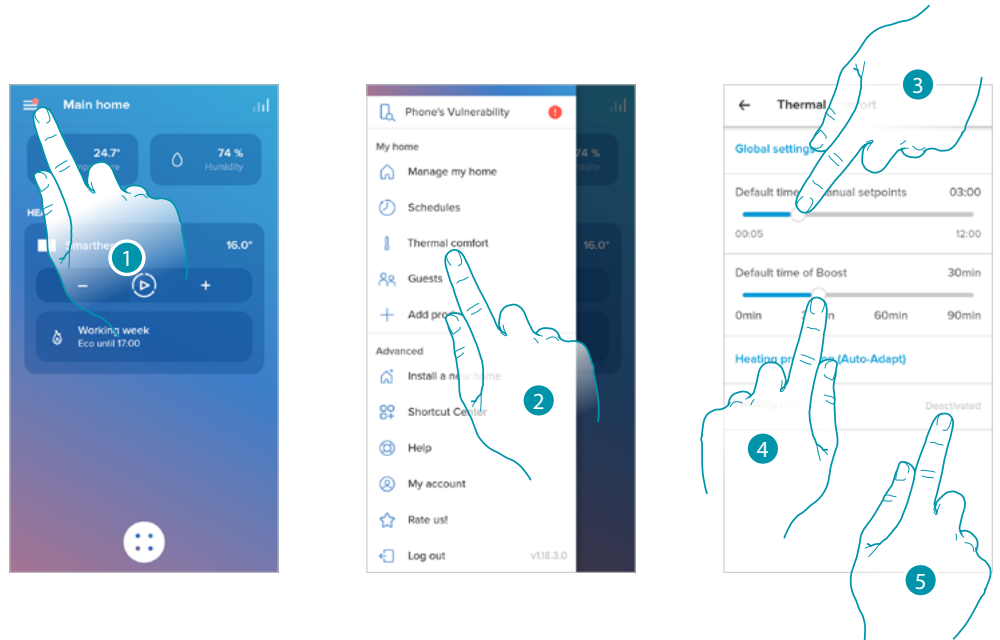

1. Touch to open the Settings menu
2. Touch to access the Thermal comfort page
3. Scroll to set the default time during which the temperature manual setting function will remain active.
4. Scroll to set the default time for the duration of the boost function.
5. Touch to access the function that automatically calculates in how long the programmed temperature will be reached..

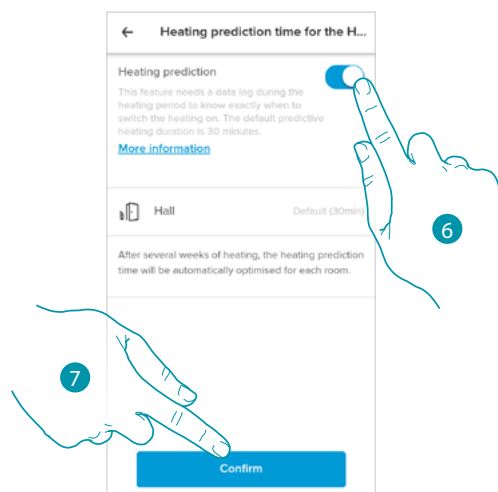

6. Touch to activate the function; by default, the system is started 30' before the set time. The correct value will then be calculated based on the environmental parameters. The final result is that the set temperature will be reached exactly at the programmed time.
7. Touch to confirm

Chart

In this section it is possible to display the Smarter and Netatmo thermostat valve switching on and switching off charts.

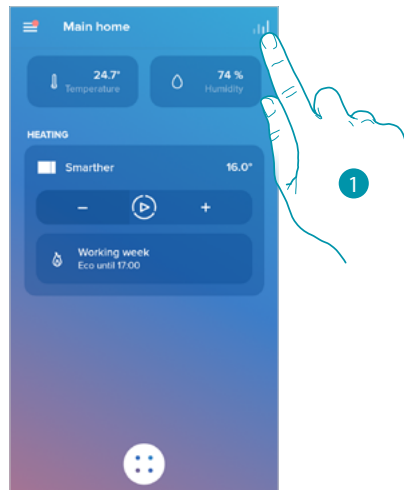

1. Touch to access the graphic page

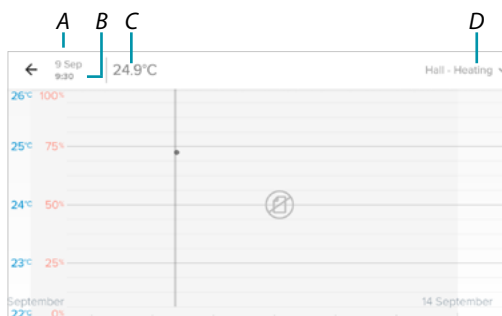

- A Day
- B Time
- C Set-point
- D Select room and temperature/humidity

Manage my guests

In this section you can display the users who can interact with your Smarther, invite new ones or if necessary delete them (the user will not be deleted, just the possibility of interacting with this Smarther).

Note: if Home + Control includes several connected devices, the invited users will have the possibility of interacting with all of them.

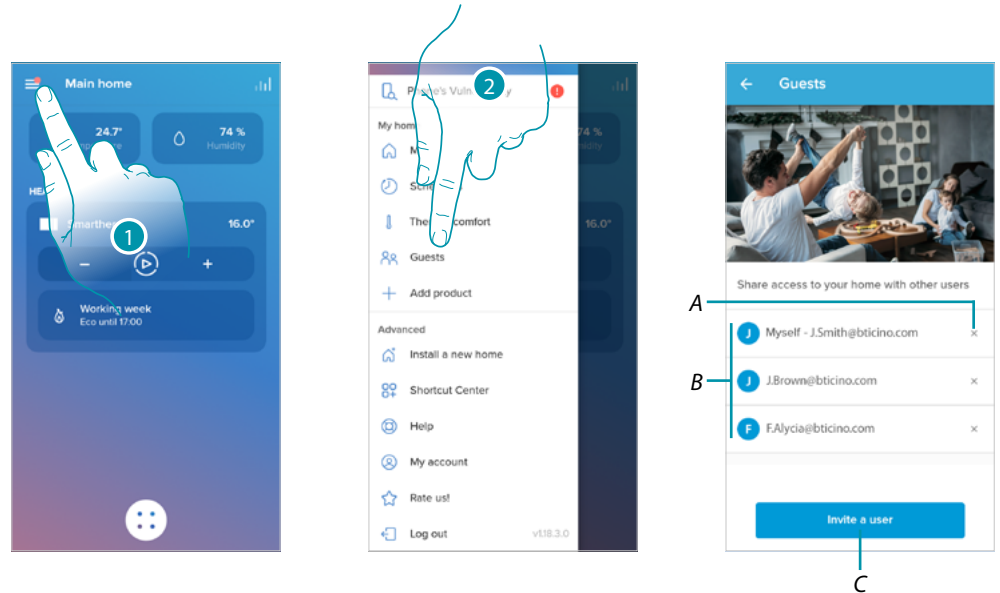

1. Touch to open the Settings menu
 2. Touch to access the guest management page
- A [Delete a user](#)
 - B [List of users](#)
 - C [Invite a user](#)

Invite a user

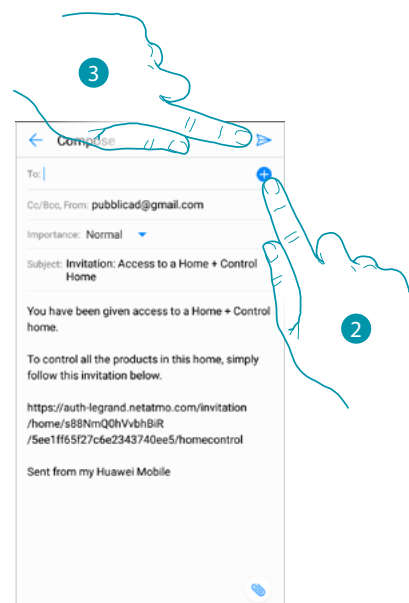
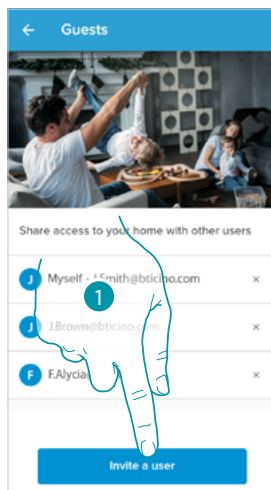

1. Touch to invite one or more people to control your home devices
2. Touch to add the contact using the address book of your smartphone, or enter the email address

Note: the contact saved in the address book must contain the email address

3. Touch to send the invitation

Once the guests accept the invitation, register and access the App, they can be found in the list of enabled users.

Delete a user

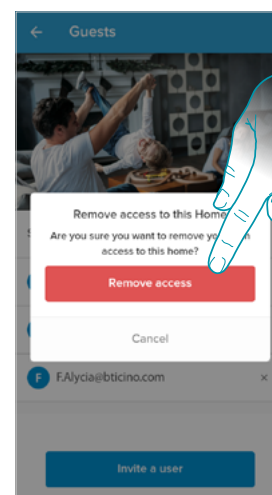
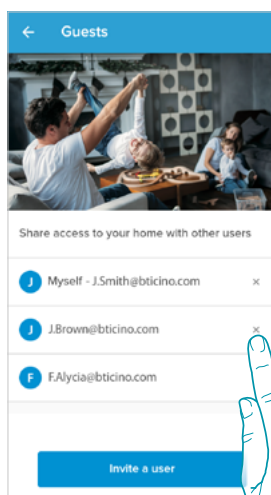

1. Touch to delete the user
2. Touch to confirm. The user can no longer control the Smarter.

Add a product to this home

In this section it is possible to add connected devices.

This procedure is necessary for both adding a new device and replacing an existing one

Note: the procedure below is only valid for adding or replacing a Smarter. In order to add or replace other connected devices, refer to the specific manual.

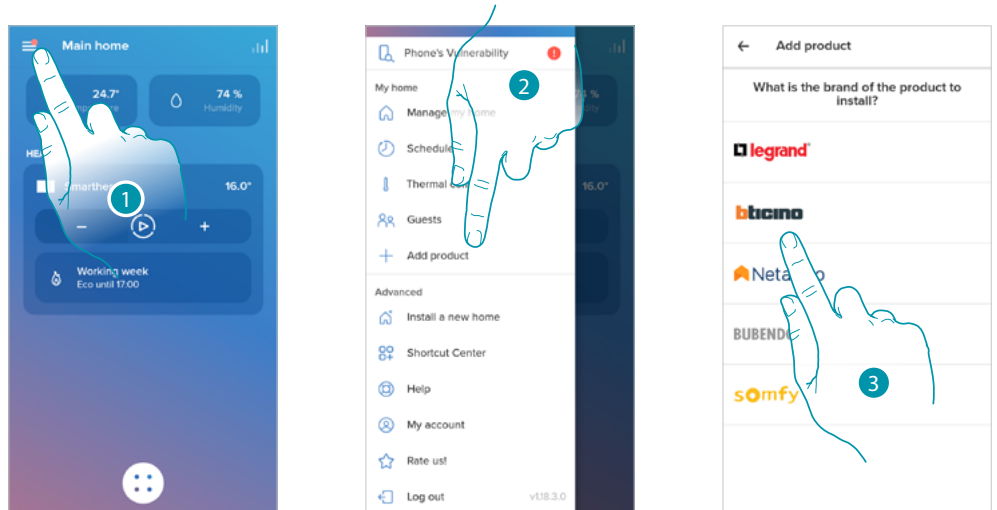

1. Touch to open the Settings menu
2. Touch to add a product into the home
3. Touch to select the brand of the product to install

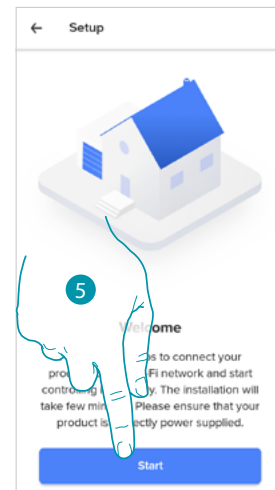
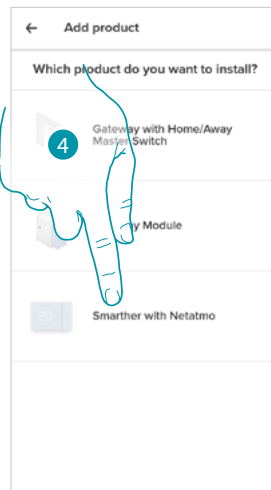

4. Touch to select the Smarter
5. Touch to start, see [Associate your Smarter](#)

Add valves to the Smarter thermostat

In this section it is possible to add Netatmo thermostat valves installed in the home in combination with the Smarter thermostat.

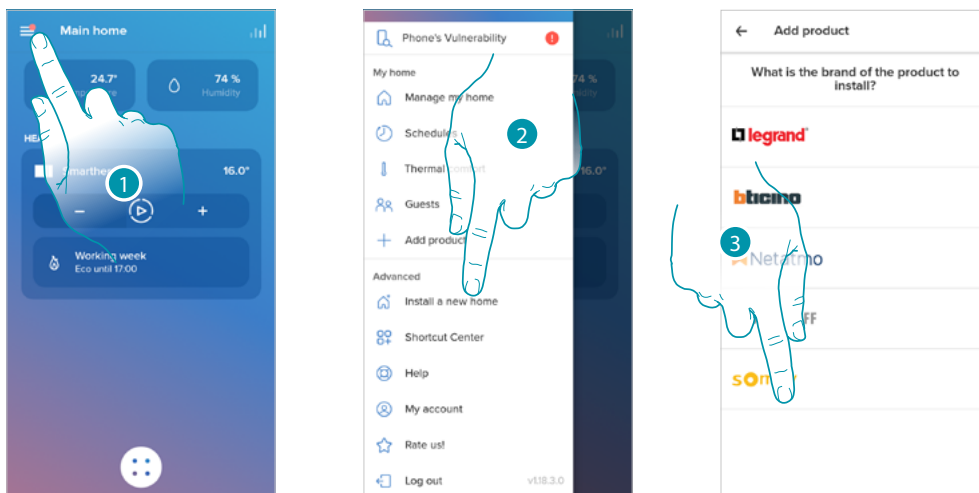

1. Touch to open the Settings menu
2. Touch to add a product into the home
3. Touch to select the brand of the product to install

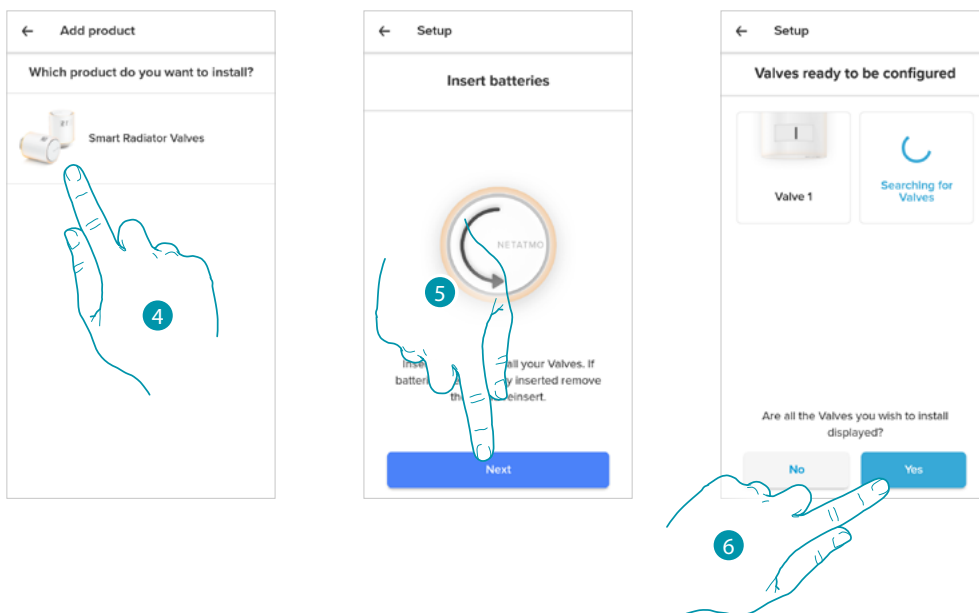

4. Touch to select the Netatmo thermostat valves associated with the Smarter
5. Insert the batteries in the Netatmo thermostat valve and touch to continue
Note: if the valves are not detected, remove and reinsert the batteries.
6. Touch to confirm that all the Netatmo thermostat valves of the home have been displayed

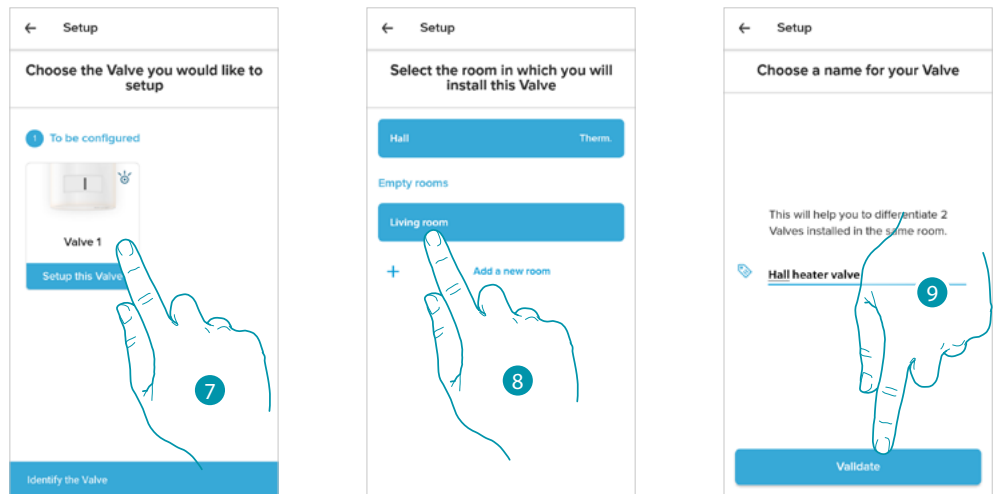

7. Touch to install the Netatmo thermostat valve
8. Select the room where the Netatmo thermostat valve is located
9. Give the Netatmo thermostat valve a custom name and touch to continue

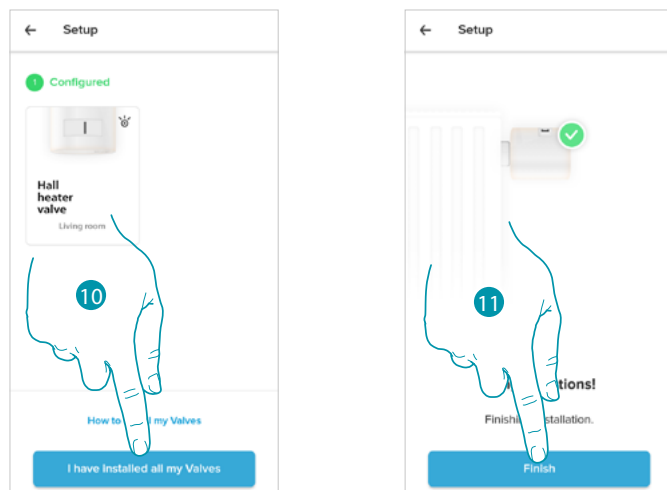

10. Install the valve on the radiator following the Netatmo manual and touch to confirm
11. Touch to end the installation of the Netatmo thermostat valve

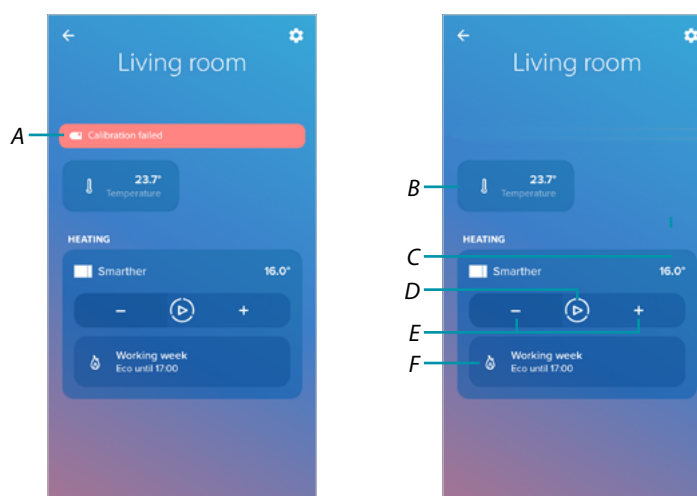

A A warning message appears if the calibration fails. The calibration can be performed in the [valve settings section](#), or wait a few minutes for the automatic calibration.

B Measured temperature

C Set temperature

D Set the [Boost function](#)

E Set the [Temperature](#)

F It opens the [Programs](#) section where it is possible to manage the schedules for the whole home

It is possible to change some parameters of the Netatmo Valve in the [Netatmo Valve settings](#) section

Install a new home

This function allows to install a new home associated with your account (e.g. Mountain home)

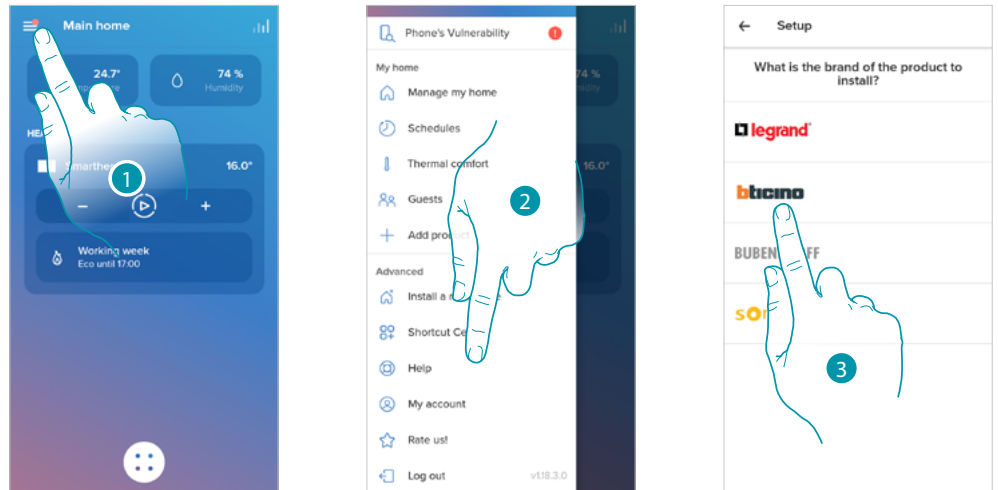

1. Touch to open the Settings menu
2. Touch to install a new home
3. Touch to select the brand of the product to install

After installing a new home, it will be possible to select which home to display and control

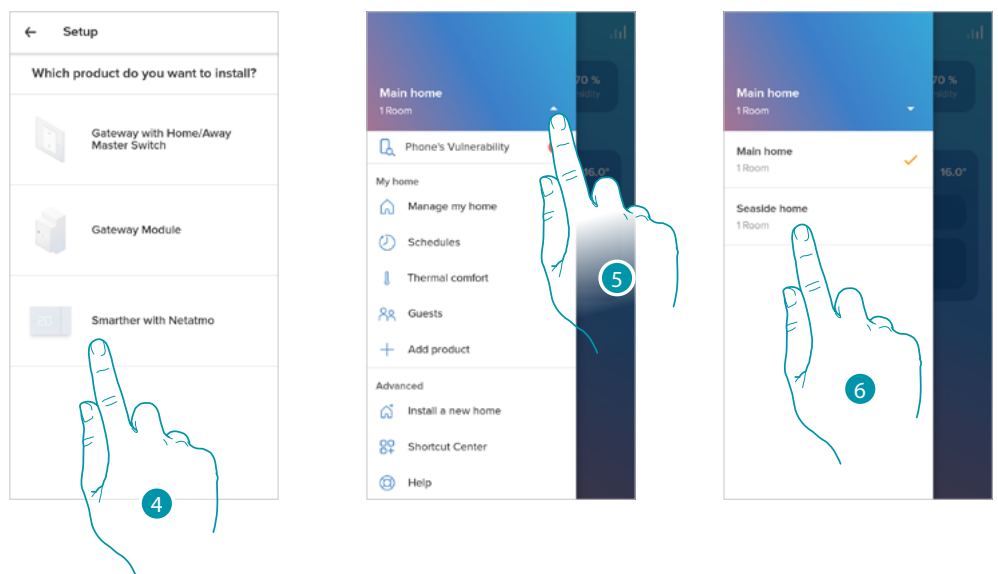

4. Touch to select the Smarter and complete the procedure described in the [Associate your Smarter](#) procedure
5. Touch to display the homes available
6. Touch to select the home to display and control

Quick selections

This section can be used to add to your smartphone Home page some preset quick selections to control your Smarter

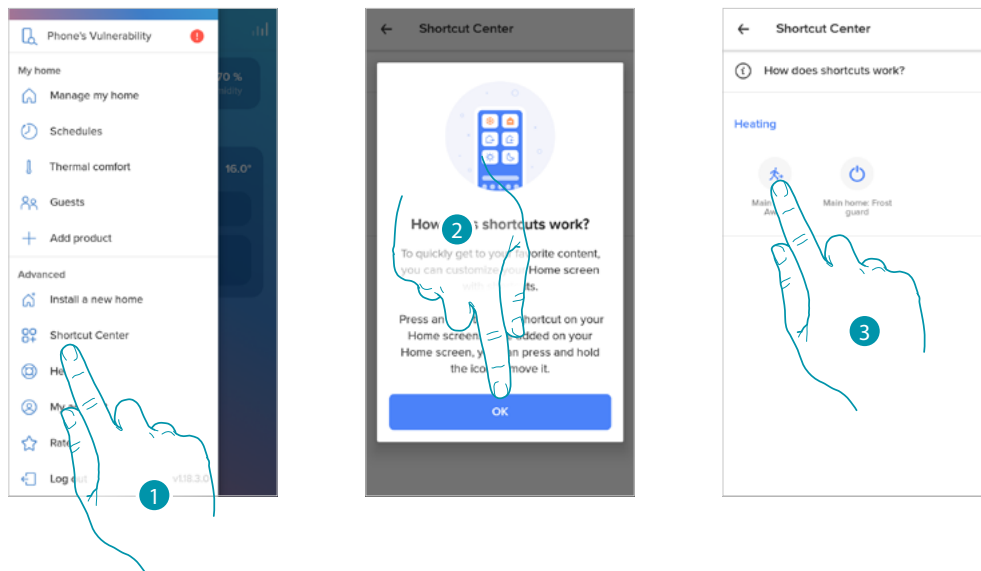

1. Touch to enter the quick selections section
2. Touch to start the configuration of the quick selections
3. Select the type of quick selection to add to your smartphone Home page

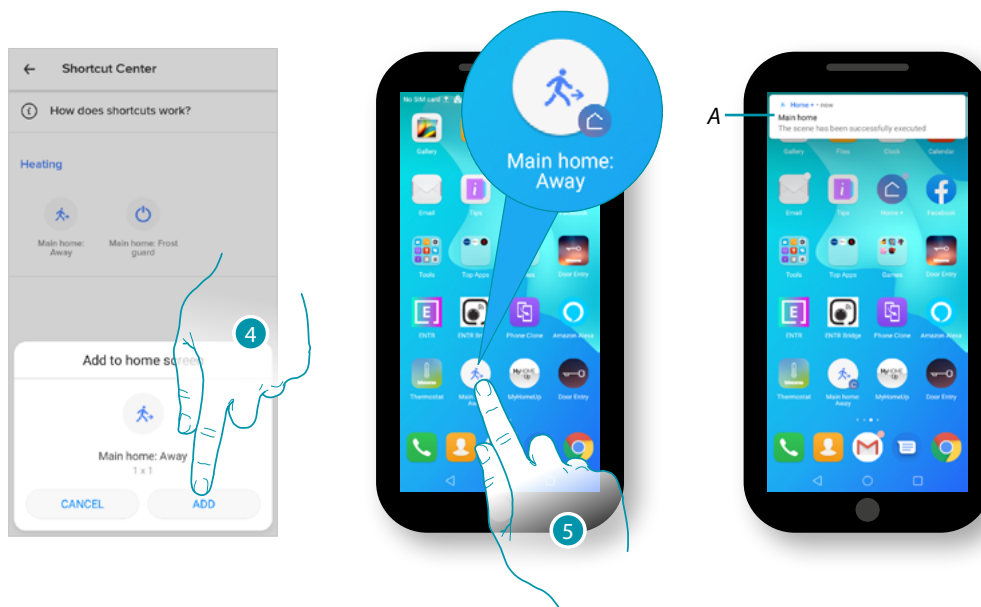

4. Touch to add the quick selection to the Home page
5. Touch to activate the quick selection
- A A notification confirms that the quick selection has been activated

Help

In this section it is possible to display FAQ (and their answers) regarding the use of the Home + Control app.

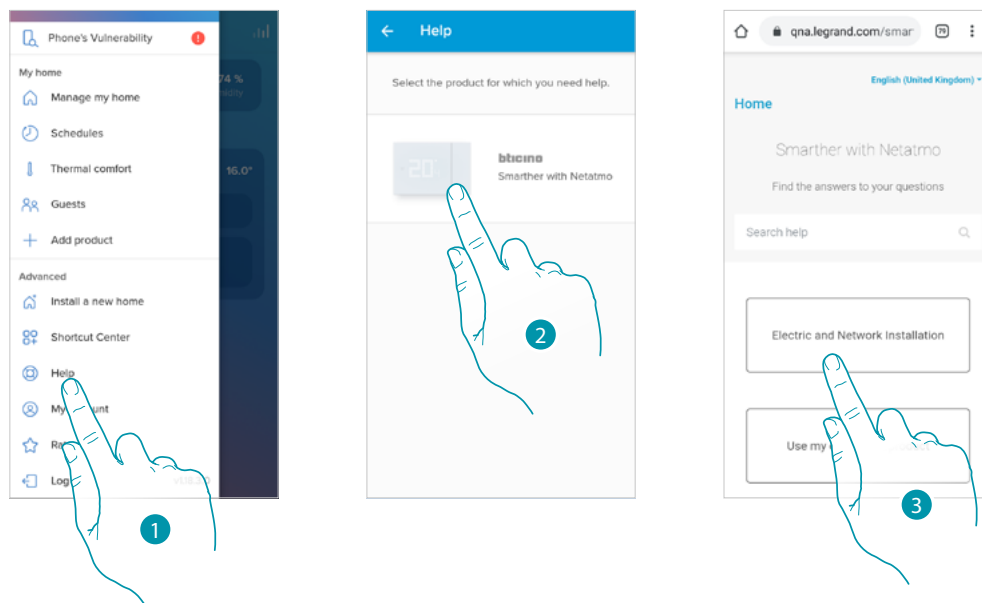

1. Touch to enter FAQ section
2. Touch to select the product for which you need help
3. Select the topic on which you require clarifications

My account

In this section it is possible to view and display some functions regarding your account.

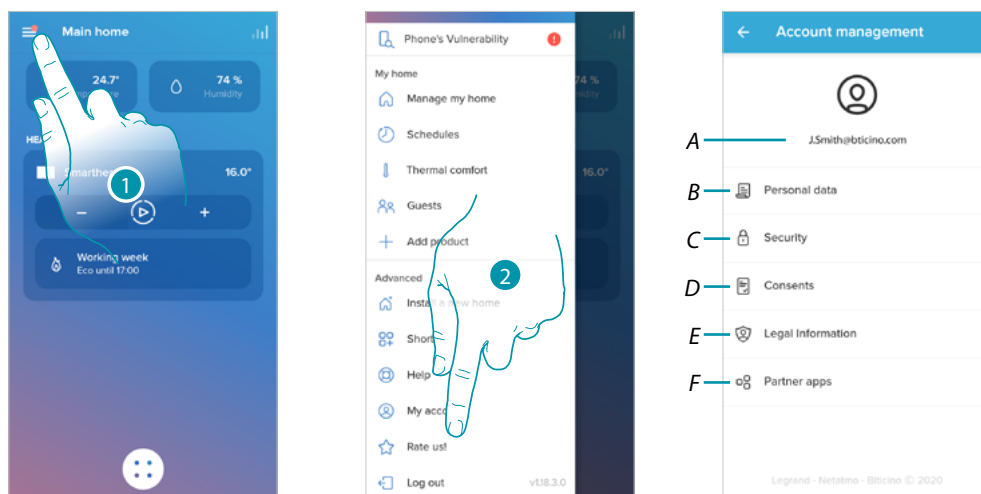

1. Touch to open the Settings menu
2. Touch to enter the account section

A Account Login/Email address

B Display/modify your Legrand account [registration details](#)

C Modify some [safety parameters](#) of your account, such as password and disconnection from all devices

D Manage your communication [authorisations](#) and other aspects of your personal details

E Display [contract terms and conditions](#) regarding the Legrand apps that you are using

F Manage le [partner apps](#) to which your account is connected (e.g. Google Home etc.)

Personal data

This section may be used to change some data of the account currently managing the device, or to replace it with another registered Legrand account.



A Current email/account

B Nation of residence

Email/account (validate your email/account)

To receive communications from the Legrand group it is necessary to validate the email address

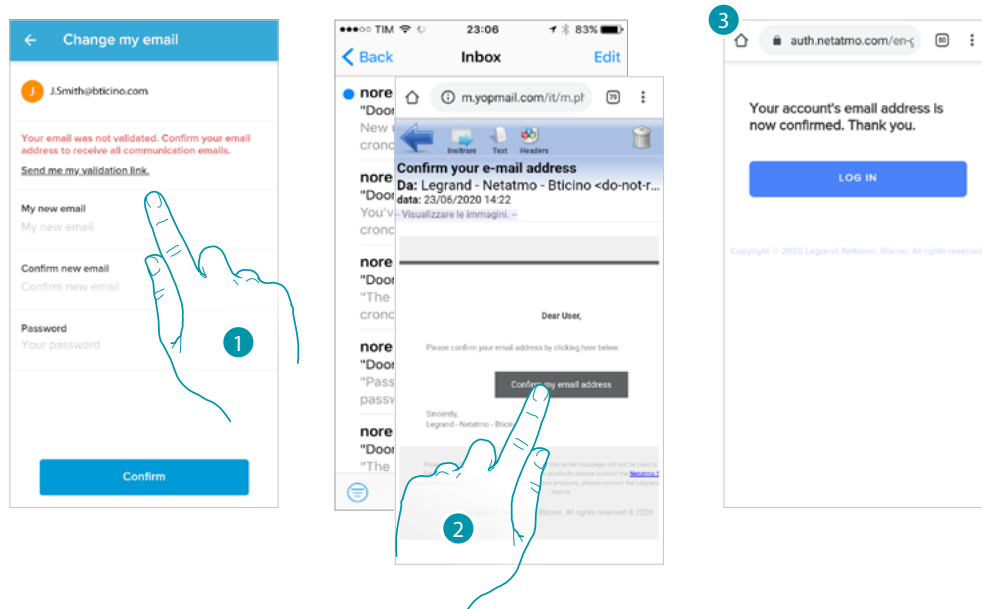

1. Touch to receive the validation link email
2. Touch the link in the email received from the system
3. The screen confirming the validation of your email address appears

Email/account (change of the device management email/account)

To change the access email address

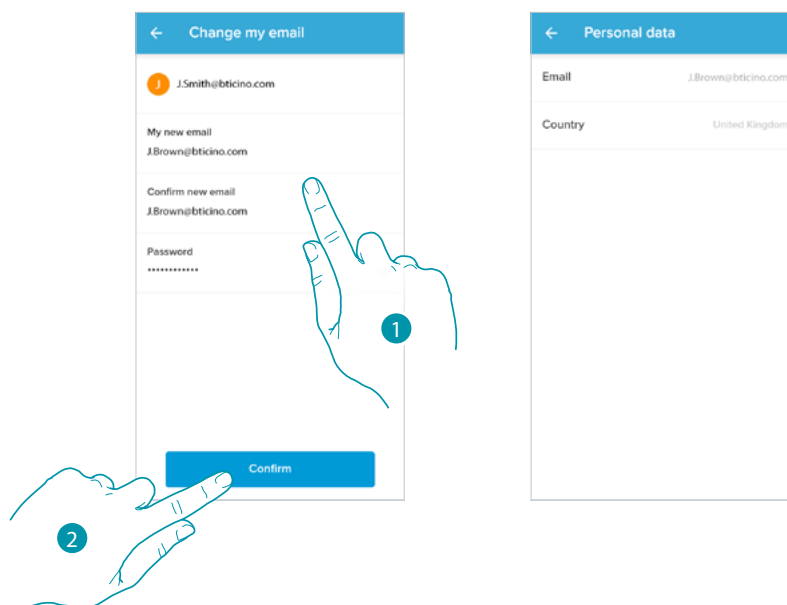

1. Enter the login details (email and password) of the new registered Legrand account to be used to manage the device
2. Touch to confirm

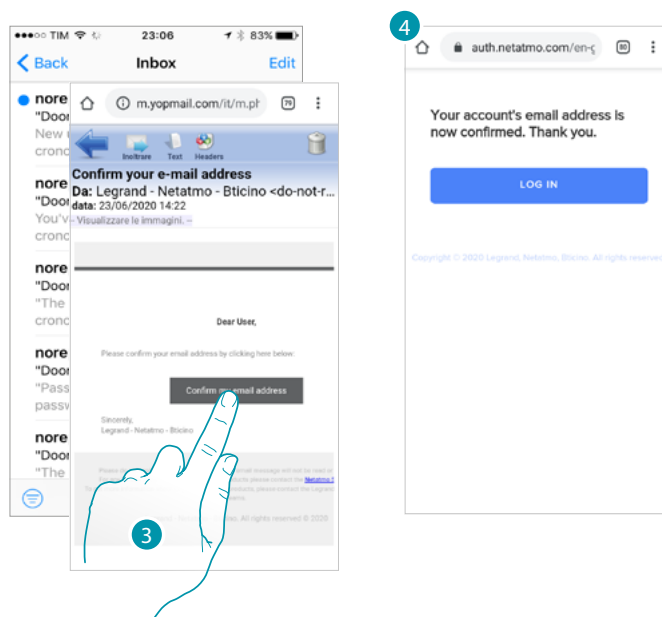

3. Touch the link in the email received from the system
4. The screen confirming the validation of the email address appears

Safety

This section can be used to change the password of your account and to disconnect it from all devices. The disconnection of your account from all devices is useful in case one of your devices is lost or stolen.

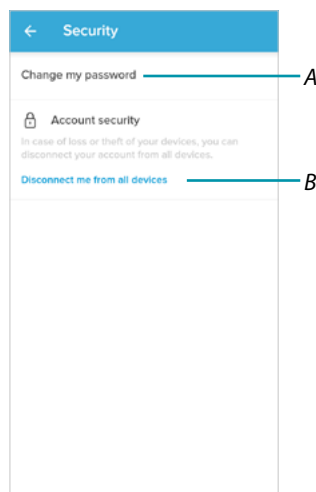

- A Complete the password change procedure
- B Disconnect from all devices

Modify password

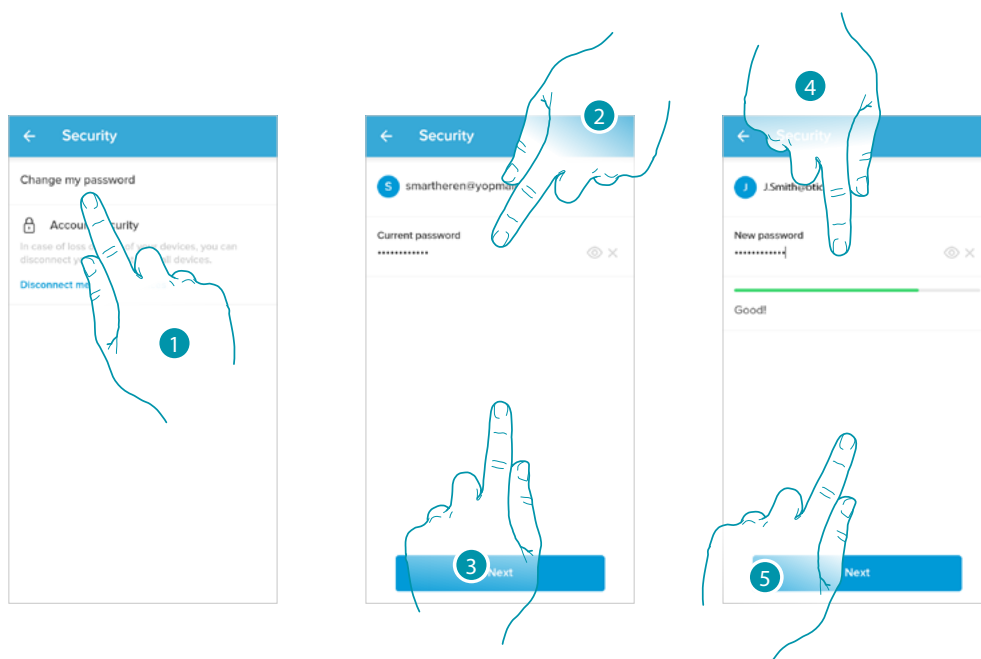

1. Touch to modify the password
2. Enter the current password
3. Touch to continue.
4. Enter the new password, which must meet the following requirements:
 - at least 8 characters;
 - at least one lower case letter (e.g. a);
 - at least one upper case letter (e.g. A);
 - at least one number (e.g. 1);
 - at least one special character (e.g. \$);
5. Touch to confirm

Disconnect from all devices

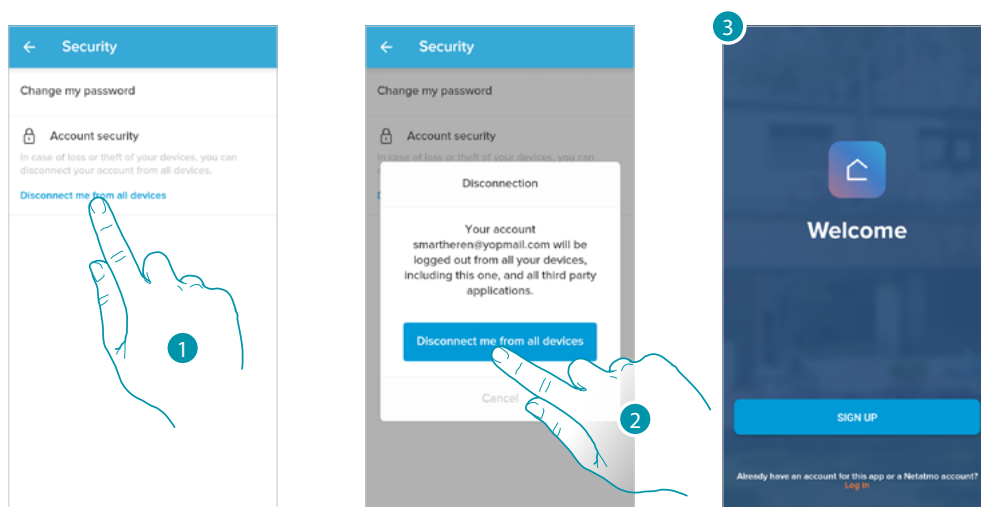

1. Touch to activate the procedure
2. Touch to disconnect your account from all the devices and all the third-party applications.
3. The system automatically logs out from the application and the Home Page appears.

Authorisation

This section can be used to enable the reception of communications from Legrand and the sharing of the App usage data.

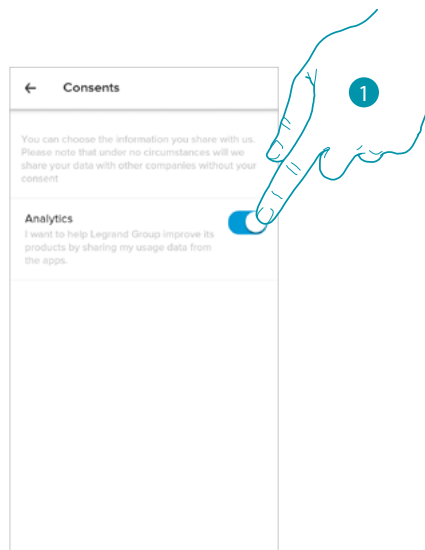

1. Touch to enable data sharing.

Legal information

Using this section you will be able to view terms and conditions of use and privacy information for each App to which your Legrand account is associated

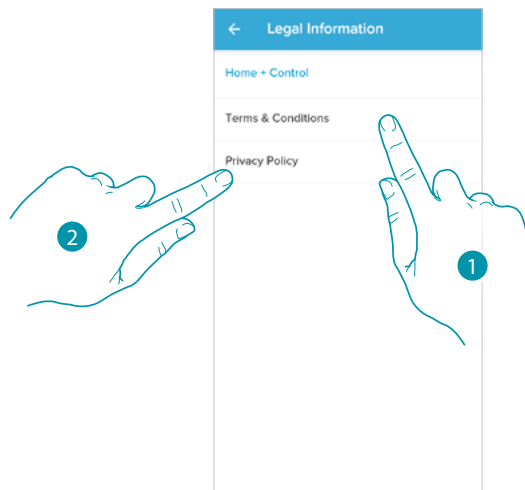

1. Touch to display Terms and Conditions
2. Touch to view Privacy information

Partner apps

In this section you can display all the third parties to whom you granted rights to operate on your connected devices. (E.g.: HOMEKIT, Google home etc.)

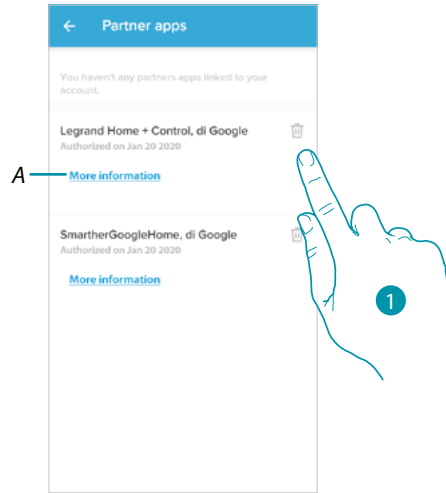

- 1. Touch to remove the access of sites or Apps to some of your account data
- A Display more information regarding the access to your system by partner Apps.

Tell us what you think!

This section can be used to rate the application.

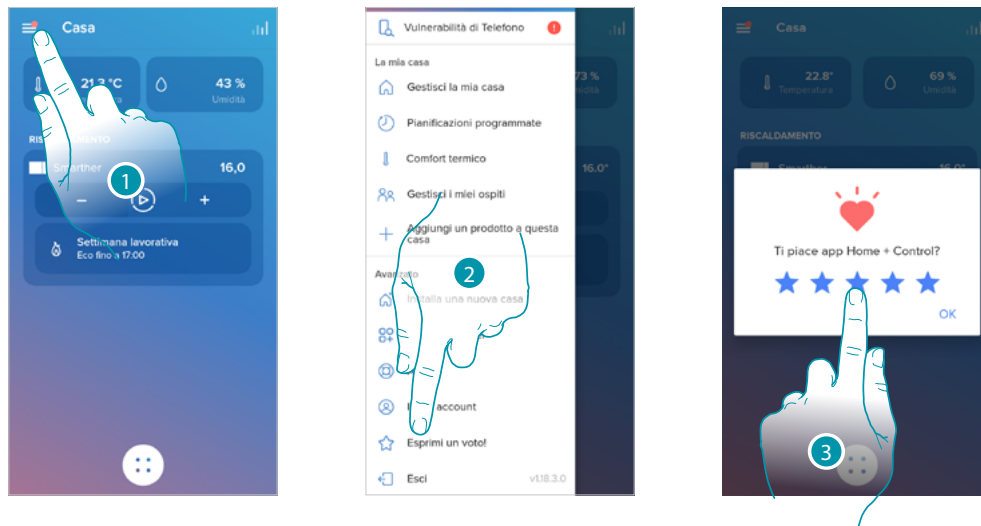

1. Touch to open the Settings menu
2. Click to rate the App
3. Touch the stars to rate the App from 1 to 5.

Logout

In this section it is possible to log out from the Home + Control App

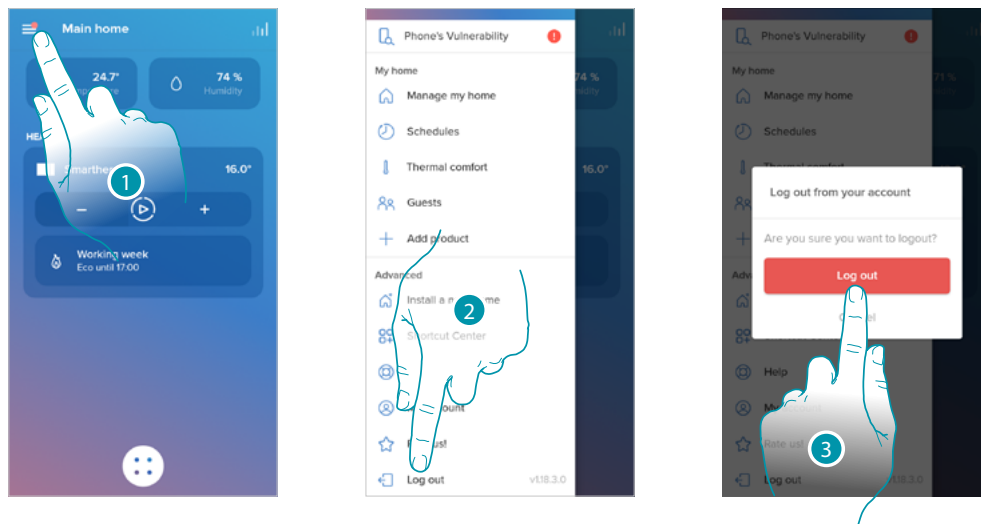

1. Touch to open the Settings menu
2. Touch to exit the App
3. Touch to confirm the intention to leave the App. The login screen will then be displayed

Reset

Resetting the Wi-Fi configuration and the HOMEKIT settings

This action deletes the Wi-Fi configuration and the HOMEKIT settings

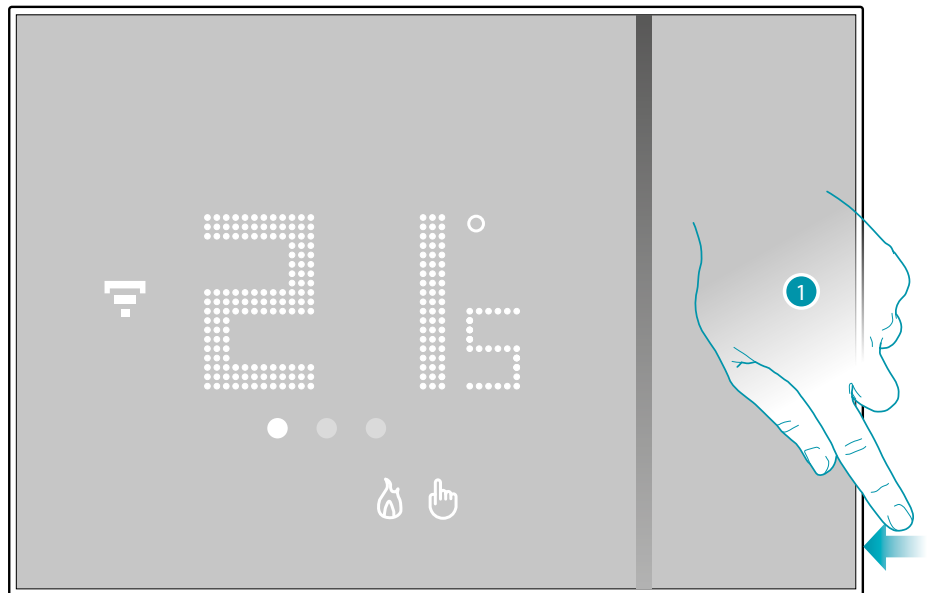

1. Keep pressed the reset pushbutton on the side of the Smarter
A countdown will start (about 5 seconds) at the end of which you will hear a confirmation beep.



2. Release the reset pushbutton.

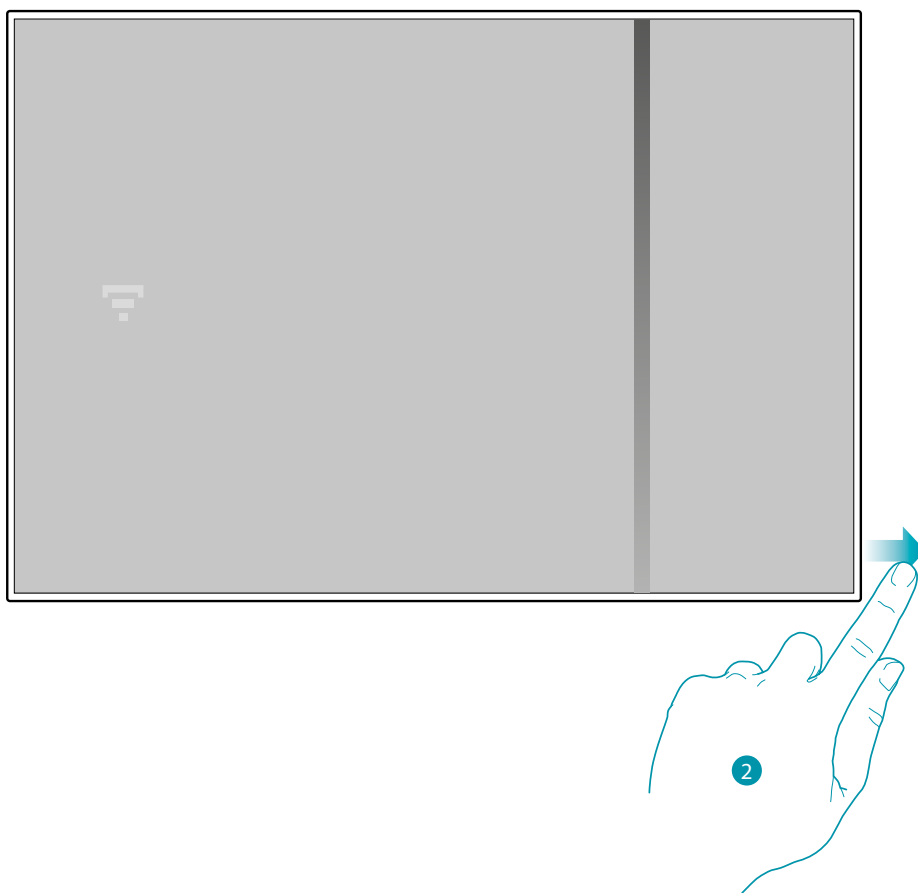

The display of the Smarter switches off

After a few seconds the Smarter comes back on. It is now possible to complete the association with Home + Control using the procedure described in the [Associate your Smarter](#) section



Reset to the factory settings

This operation restores the Smarter factory settings and all programs and associations will be deleted

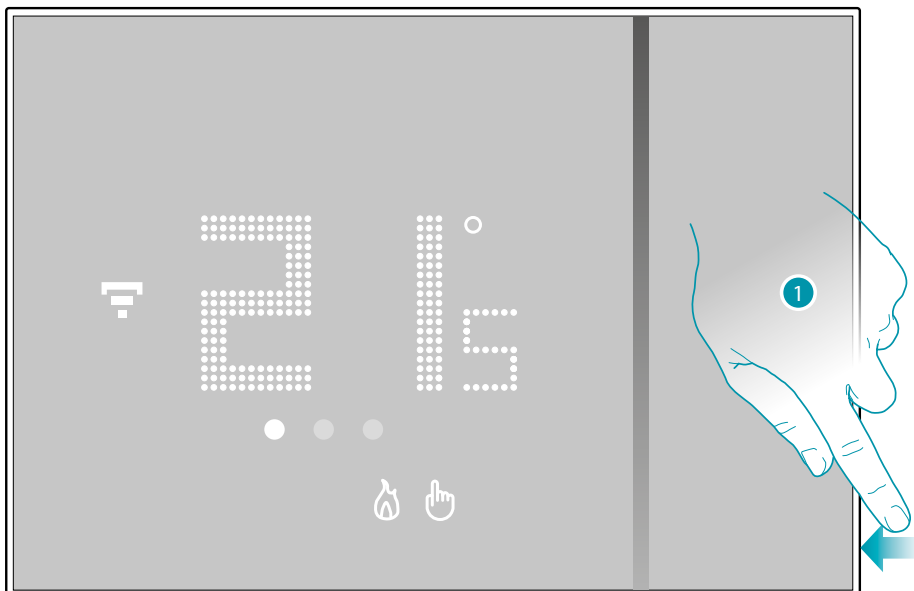

1. Keep pressed the reset pushbutton on the side of the Smarter
A countdown will start (about 5 seconds) at the end of which you will hear a confirmation beep.



0.0 flashes on the Smarter display...

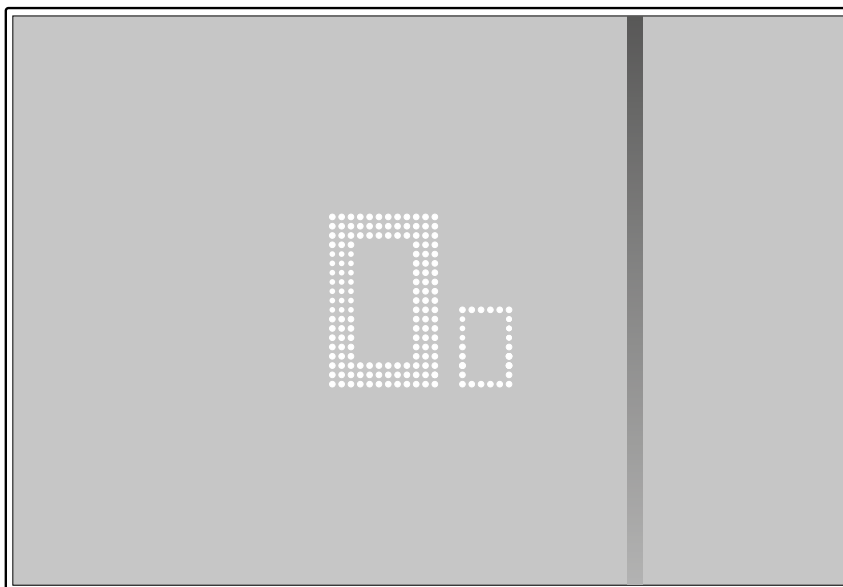

... until a confirmation beep is heard.

Note: in some cases the device reset can last up to one minute.

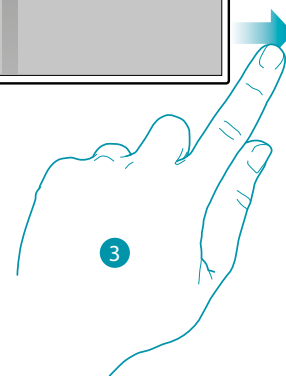

3. Release the reset pushbutton.
The display of the Smarter switches off

After a few seconds the Smarther comes back on. It is now possible to complete the association with Home + Control using the procedure described in the [Associate your Smarther](#) section

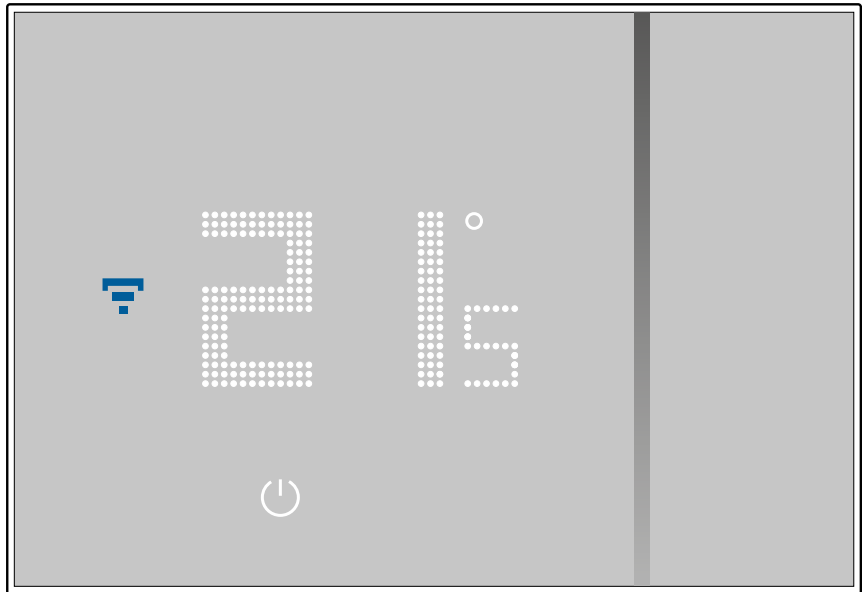

Manage your Smarter with third-party apps

Integration with third parties allows to take advantage of the voice control function, in addition to the already many functionalities of your Smarter:

- 1 you can increase/decrease the Smarter temperature, set it manually or automatically; you can request the Smarter set temperature; you can switch it on or off, or set the absolute temperature.
- 2 you can include the above commands in a scenario.

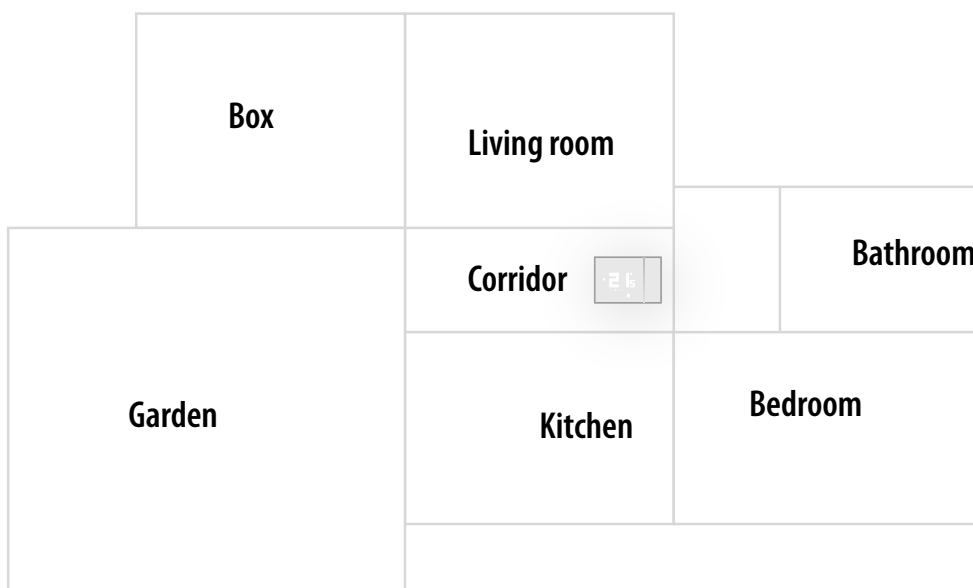
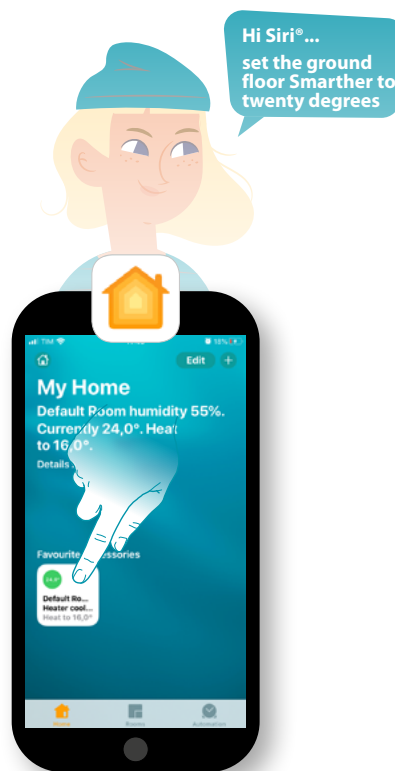

Control your Smarter with HOMEKIT

Thanks to third-party integration, you can also control your Smarter using the HOMEKIT app. The HOMEKIT app allows you to add some functions to your Smart system:

- you can also increase/decrease the Smarter temperature with your voice, using the Siri® voice assistant
- you can create new scenarios, in addition to those contemplated by Home + Control
- the created scenarios can be used to also control third-party devices compatible with HOMEKIT

Note: to take advantage of the Home + Control integration, it will be necessary to first allow access to the HOMEKIT data during the association of Home + Control with the Smart system (see [Associate your Smarter / If you use a smartphone with iOS operating system](#), or follow the procedure below)

Note: this manual describes the procedure for association with the Smarter; in order to know all the functions in details refer to the Apple® manual (<https://support.apple.com>)

Associate the Smart system to HOMEKIT app

Note: check that the bluetooth connection is active

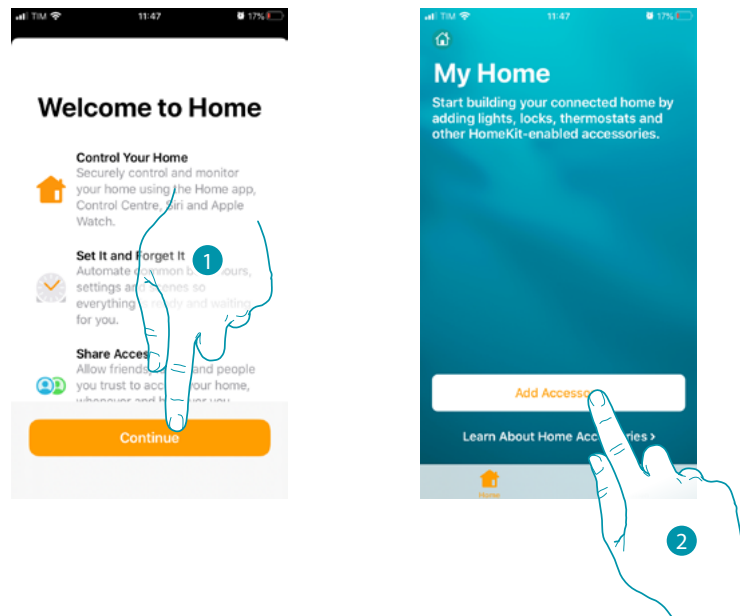

1. Open the HOMEKIT App and touch to start the association with the Smart system
2. Touch to start the association procedure

Note: if you have associated your Smarter with the Home + Control App, this process has already been completed automatically, go to the [Home Page](#) section

It is now necessary to enter the HOMEKIT code.
You can find the HOMEKIT code:

- on the back of the instruction sheet



- on the back of the Smarter



- on the protective film of the Smarter

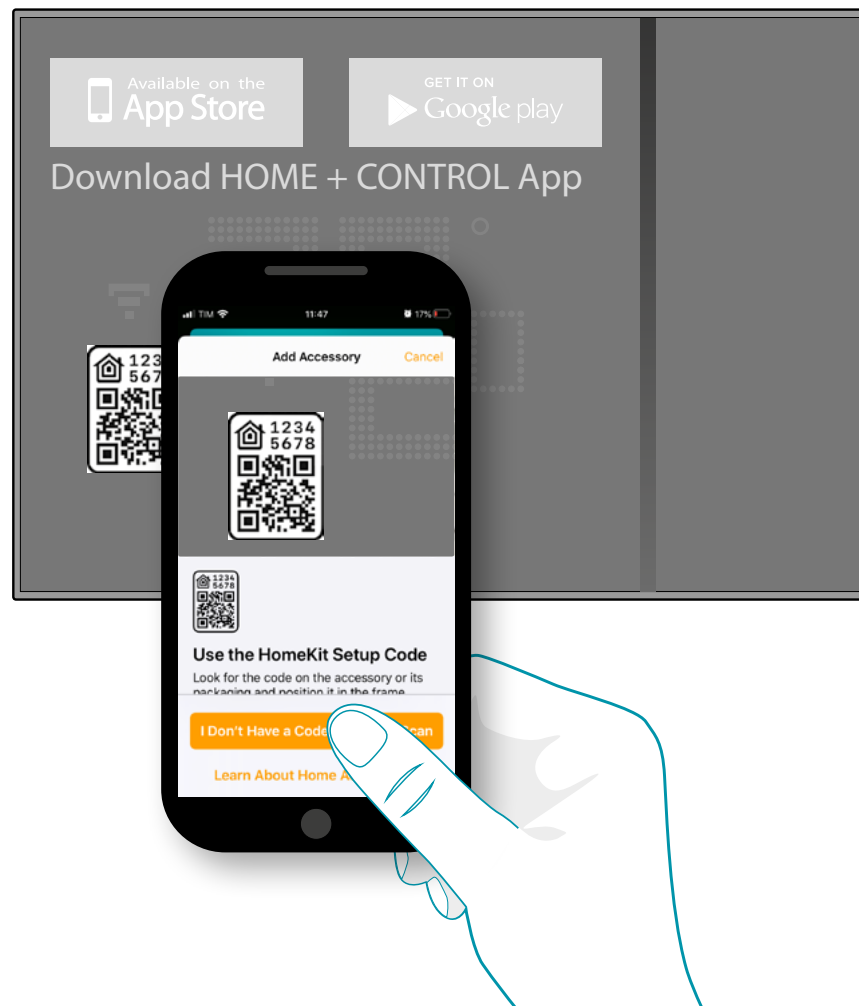

Frame the code on the Smarter: the code will be detected automatically

If the code is not detected automatically, or if it cannot be scanned

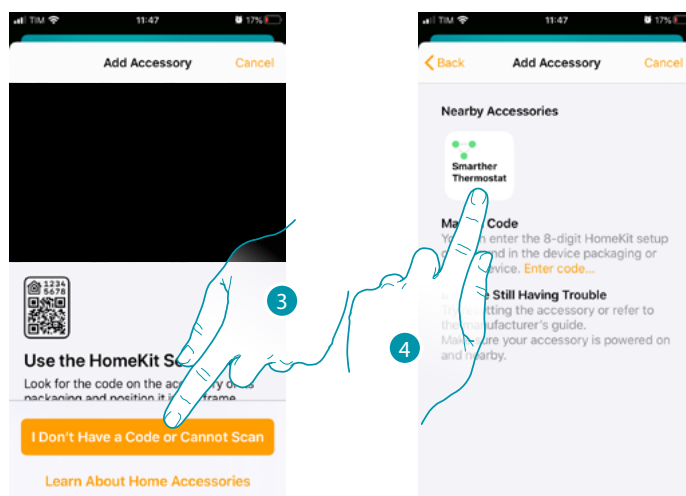

3. Touch to open the manual entering page
4. Touch the Smarter detected nearby

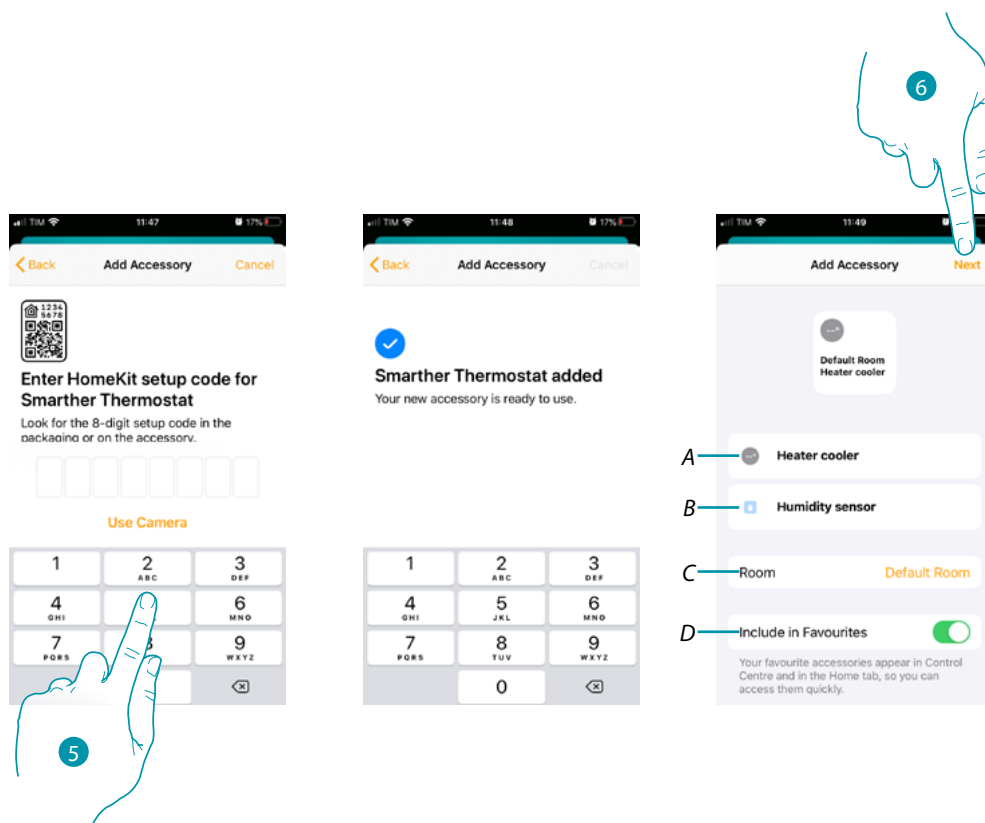

5. Manually enter the HOMEKIT code
Make sure that the smartphone is being charged and within the range of the Gateway.
- A *Rename the Smarter for the heating function*
- B *Rename the Smarter for the humidity detection function*
- C *Select the room/create a new one where to insert the Smarter within the HOMEKIT App*
- D *Add/remove from favorites*
6. Touch to continue

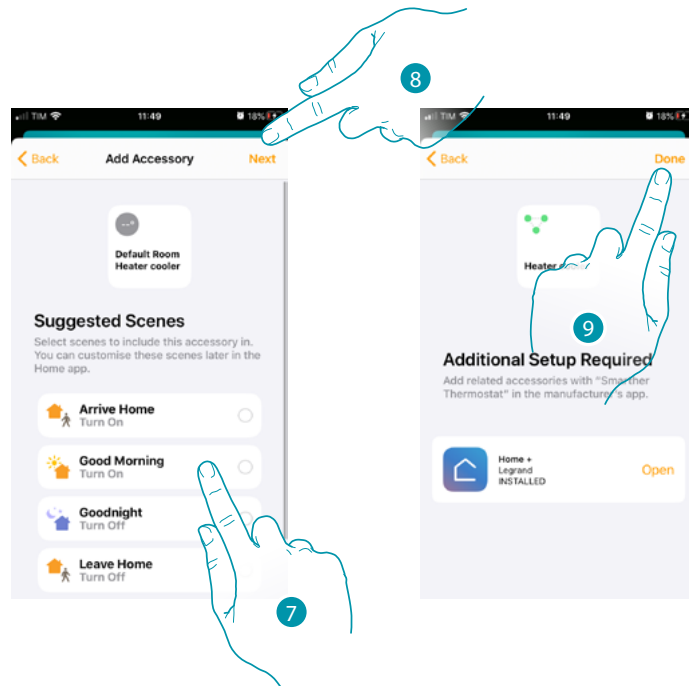

7. Touch to select the scenarios where you want to include the Smarter
8. Touch to continue.
9. Touch to end the configuration of the HOMEKIT App

From the Home Page of the HOMEKIT app, it is possible to safely control the devices, organised into room and installed in your home.

For a detailed knowledge of all the functions refer to the Apple® documentation.



Legrand SNC
128, av. du Maréchal-de-Lattre-de-Tassigny
87045 Limoges Cedex - France
www.legrand.com

BTicino SpA
Viale Borri, 231
21100 Varese
www.bticino.com